

BR-6478 AC V2

User Manual

08-2015 / v1.0

Edimax Technology Co., Ltd.

No.3, Wu-Chuan 3rd Road, Wu-Gu, New Taipei City 24891, Taiwan

Email: support@edimax.com.tw

Edimax Technology Europe B.V.

Fijenhof 2, 5652 AE Eindhoven, The Netherlands

Email: support@edimax.nl

Edimax Computer Company

3350 Scott Blvd., Bldg.15 Santa Clara, CA 95054, USA

Live Tech Support: 1(800) 652-6776

Email: support@edimax.com

CONTENTS

I. Product Information.....	1
I-1. Package Contents	1
I-2. LED Status.....	2
I-3. Back Panel	3
I-4. Safety Information	4
II. Installation.....	5
II-1. Wi-Fi Router Mode	8
II-2. Access Point Mode.....	13
II-3. Range Extender Mode	18
II-4. Wireless Bridge Mode.....	26
II-5. WISP Mode	32
II-6. WPS Setup	40
II-7. Reset to Factory Default Settings	40
III. Browser Based Configuration Interface.....	41
III-1. Login.....	41
III-2. Save Settings.....	43
III-3. Main Menu	44
III-3-1. Status	45
III-3-2. Setup Wizard	46
III-3-3. Internet/WISP.....	48
III-3-3-1. WAN Setup	50
III-3-3-1-1. Dynamic IP.....	50
III-3-3-1-2. Static IP.....	52
III-3-3-1-3. PPPoE	54
III-3-3-1-4. PPTP	56
III-3-3-1-5. L2TP.....	58
III-3-3-2. DDNS	60
III-3-3-3. DNS Proxy.....	62
III-3-3-4. VPN Server.....	63
III-3-4. LAN	65
III-3-5. 2.4GHz Wireless & 5GHz Wireless	68
III-3-5-1. Basic	68
III-3-5-1-1. Disable.....	73
III-3-5-1-2. WEP	74
III-3-5-1-3. WPA Pre-Shared Key.....	75
III-3-5-1-4. WPA Radius	76
III-3-5-2. Guest/Multiple SSID.....	77

III-3-5-3.	WPS	81
III-3-5-4.	Access Control	82
III-3-5-5.	Schedule	84
III-3-6.	USB.....	86
III-3-6-1.	Basic Settings.....	86
III-3-6-2.	Advanced Settings	88
III-3-7.	Firewall	90
III-3-7-1.	Access Control	90
III-3-7-2.	DMZ.....	95
III-3-7-3.	DoS	96
III-3-8.	QoS.....	98
III-3-8-1.	QoS.....	98
III-3-8-2.	iQoS.....	101
III-3-9.	Advanced.....	103
III-3-9-1.	Static Routing	103
III-3-9-2.	Port Forwarding.....	104
III-3-9-3.	Virtual Server.....	106
III-3-9-4.	2.4GHz Wireless.....	107
III-3-9-5.	5GHz Wireless.....	109
III-3-9-6.	IGMP	111
III-3-9-7.	UPnP.....	112
III-3-9-8.	Fast NAT	112
III-3-10.	Administration	113
III-3-10-1.	Time Zone.....	113
III-3-10-2.	Password	114
III-3-10-3.	Remote Access.....	115
III-3-10-4.	Backup/Restore	116
III-3-10-5.	Upgrade.....	116
III-3-10-6.	Restart.....	117
III-3-10-7.	Logs	117
III-3-10-8.	Active DHCP Client	119
III-3-10-9.	Statistics	119

IV. Appendix 120

IV-1.	Configuring your IP address	120
IV-1-1.	How to check that your computer uses a dynamic IP address	121
IV-1-1-1.	Windows XP.....	121
IV-1-1-2.	Windows Vista	123
IV-1-1-3.	Windows 7.....	125
IV-1-1-4.	Windows 8.....	128
IV-1-1-5.	Mac OS	132
IV-1-2.	How to modify the IP address of your computer	134

IV-1-2-1.	Windows XP.....	134
IV-1-2-2.	Windows Vista	136
IV-1-2-3.	Windows 7.....	137
IV-1-2-4.	Windows 8.....	140
IV-1-2-5.	Mac	144
IV-1-3.	How to Find Your Network Security Key.....	147
IV-1-3-1.	Windows 7 & Vista.....	147
IV-1-3-2.	Mac	149
IV-1-4.	How to Find Your Router’s IP Address.....	152
IV-1-4-1.	Windows XP, Vista & 7	152
IV-1-4-2.	Windows 8.....	154
IV-1-4-3.	Mac	157
IV-2.	Connecting to a Wi-Fi network.....	159
IV-3.	FAQs	161

V. Glossary.....165

I. Product Information

I-1. Package Contents

Before you start using this product, please check if there is anything missing in the package, and contact your dealer to claim the missing item(s):



BR-6478AC V2



CD-ROM

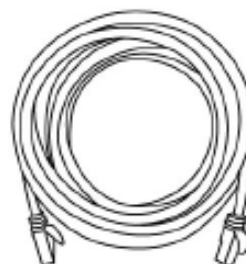

Ethernet Cable





Quick Installation Guide



Power Adapter

I-2. LED Status

LED	Color	Status	Description
Power 	White	On	The device is on.
		Off	The device is off.
Internet 	Blue	On	Internet connection is ready.
		Flashing	Restoring to factory default state, or Ethernet cable not connected, or no Internet connection.
Wi-Fi 	Blue	On	2.4G and/or 5G Wi-Fi wireless activity (transferring/receiving data).
		Flashing	WPS is active.
		Off	Wi-Fi not active.
USB	Blue	On	USB connection is ready.
		Off	USB is not active.

I-3. Back Panel

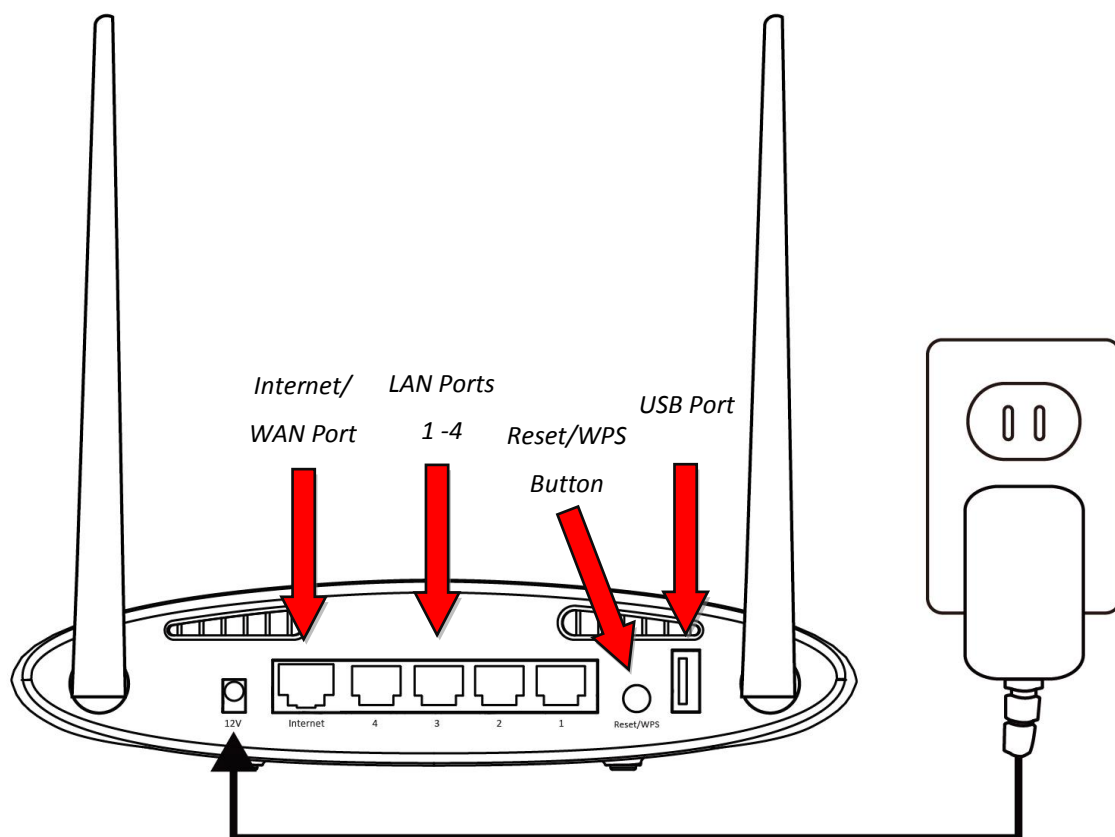

I-4. Safety Information

In order to ensure the safe operation of the device and its users, please read and act in accordance with the following safety instructions.

1. The device is designed for indoor use only; do not place it outdoors.
2. Do not place the device in or near hot/humid places, such as a kitchen or bathroom.
3. Do not pull any connected cable with force; carefully disconnect it from the BR-6478 AC V2.
4. Handle the device with care. Accidental damage will void the warranty of the device.
5. The device contains small parts which are a danger to small children under 3 years old. Please keep the device out of reach of children.
6. Do not place the device on paper, cloth, or other flammable materials. The device may become hot during use.
7. There are no user-serviceable parts inside the device. If you experience problems with the device, please contact your dealer of purchase and ask for help.
8. The device is an electrical device and as such, if it becomes wet for any reason, do not attempt to touch it without switching the power supply off. Contact an experienced electrical technician for further help.

II. Installation

1. Plug the included power adapter into the device's 12V DC power port and the other end into an electrical socket.

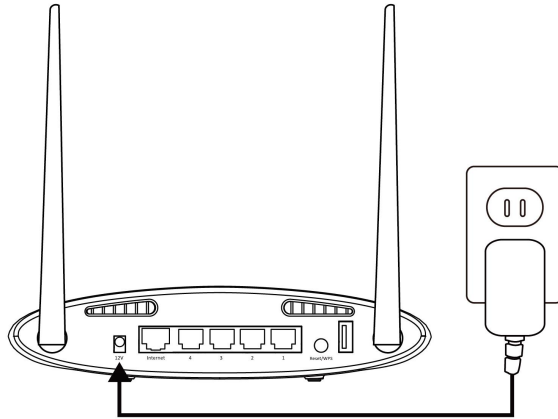

2. Check that the power LED displays on.

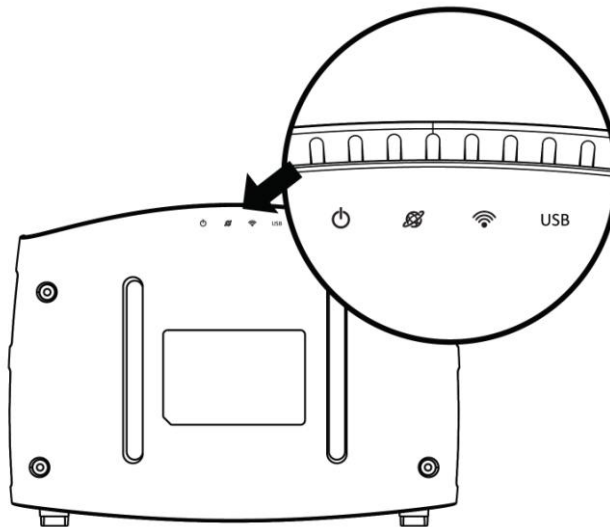

3. Use a Wi-Fi device (e.g. computer, tablet, smartphone) to search for a Wi-Fi network with the SSID "edimax.setup" or "edimax.setup5G" and connect to it.



iOS 4 or Android 4 and above are required for setup on a smartphone or tablet.

4. Open a web browser and if you do not automatically arrive at the “Get Started” screen shown below, enter the URL ***http://edimax.setup*** and click “**Get Started**” to begin the setup process.



 ***If you cannot access <http://edimax.setup>, please make sure your computer is set to use a dynamic IP address.***

5. Choose if you want to use your BR-6478AC V2 in its default Wi-Fi router mode or in a different mode.

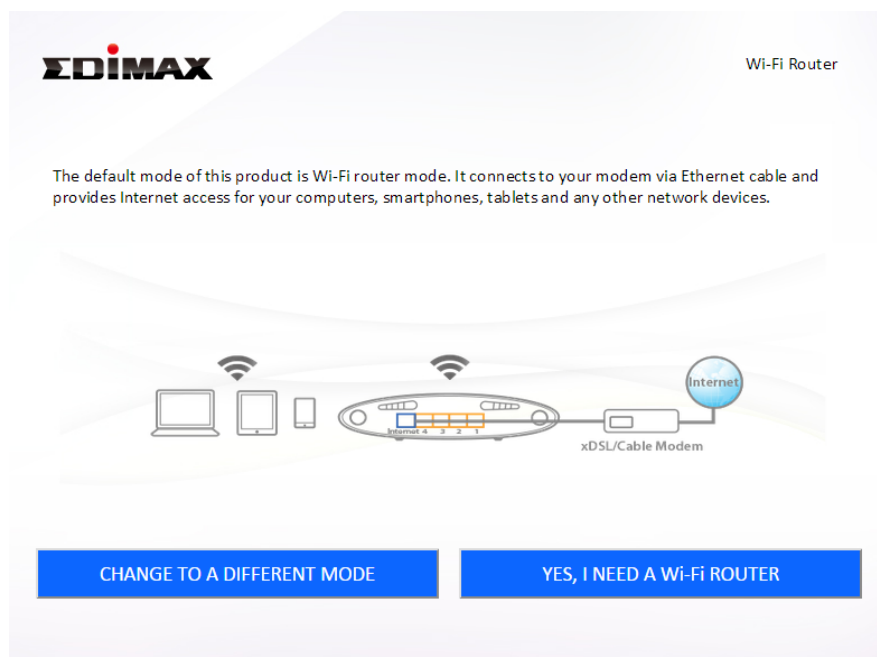

Wi-Fi Router Mode	<i>The device connects to your modem and provides</i>
--------------------------	--

	<i>2.4GHz and/or 5GHz Internet (wireless and Ethernet) access for your network devices.</i>
Access Point Mode	<i>The device connects to an existing router via Ethernet cable and provides 2.4GHz and/or 5GHz Internet (wireless and Ethernet) access for your network devices.</i>
Wi-Fi Extender Mode	<i>The device connects wirelessly to your existing 2.4GHz and/or 5GHz network and repeats the wireless signal(s).</i>
Wi-Fi Bridge Mode	<i>The device connects to a network device for example: TV, gaming console, or media player via Ethernet cable and acts as a Wi-Fi bridge, allowing the network device to join your Wi-Fi network.</i>
WISP Mode	<i>The device connects wirelessly to your Wireless Internet Service Provider and provides 2.4GHz and/or 5GHz Internet (wireless and Ethernet) access for your network devices.</i>

6. Follow the on-screen instructions to complete setup. Refer to the following chapters if you need more help.

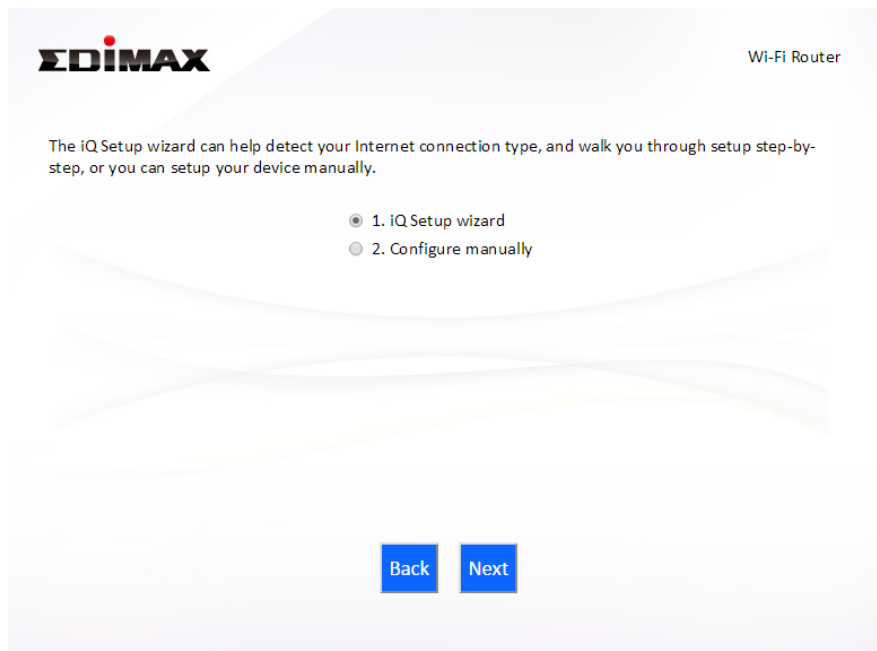

II-1. Wi-Fi Router Mode

1. Select whether to use the iQ Setup wizard (recommended) to detect your Internet connection type, or enter the settings manually.



Manual configuration is only recommended for advanced users.

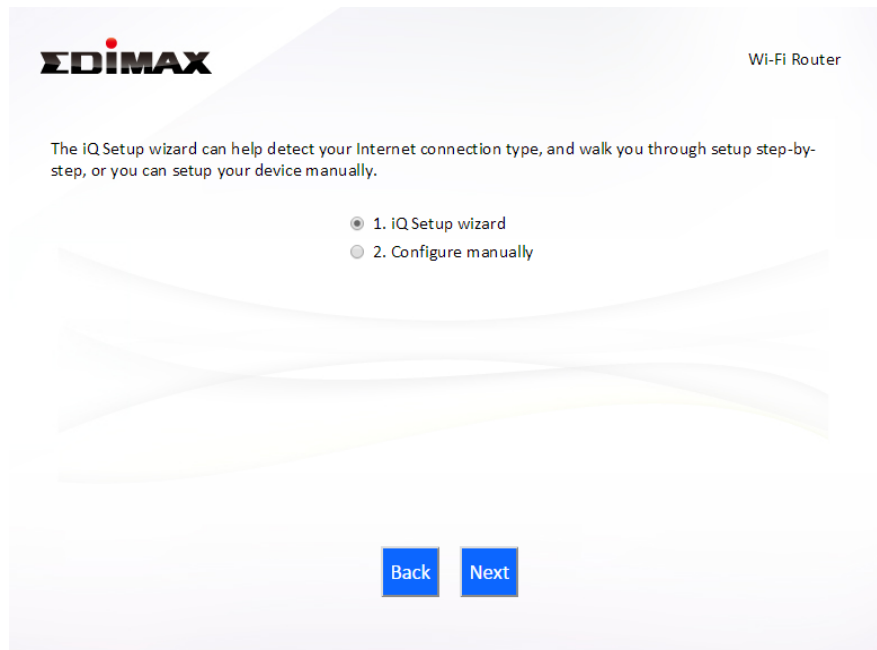

2. Connect the **blue** Internet port of your device to the LAN port of your modem using an Ethernet cable, and then click “Next”.

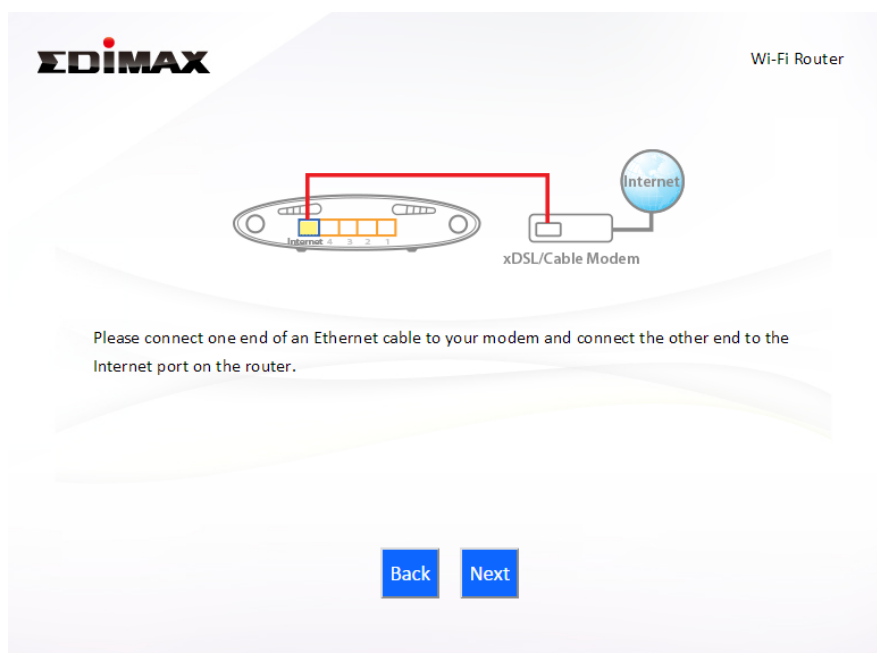

3. Please wait a moment while the device tests the connection.

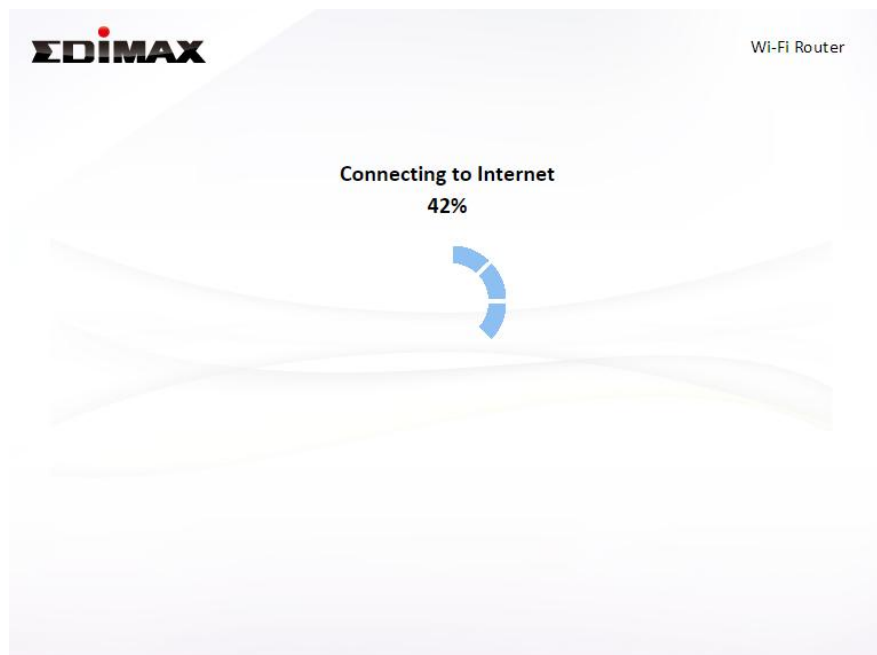

4. Click “Next” to continue and configure the device’s wireless network.

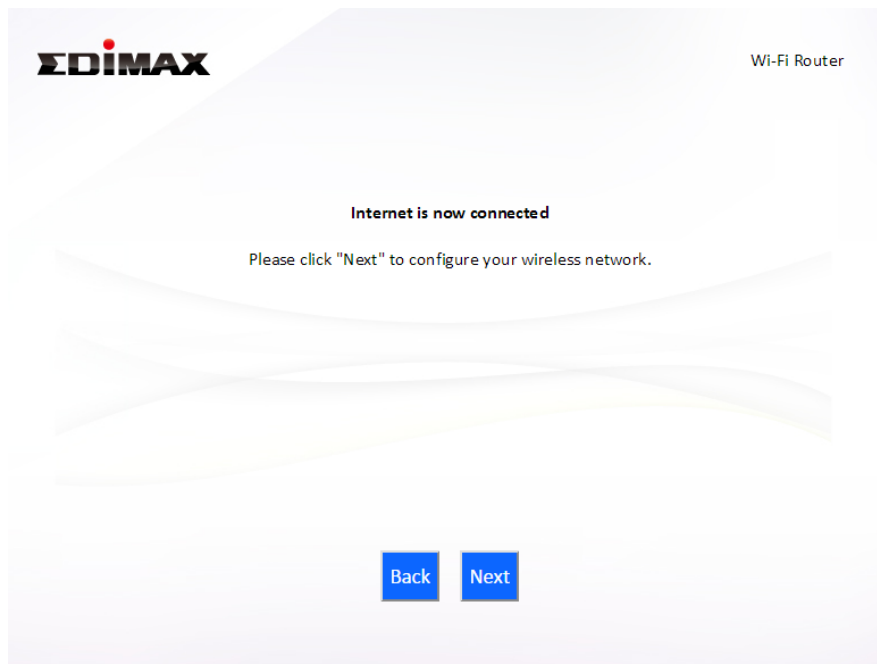

5. Enter a name and password for your 2.4GHz & 5GHz wireless networks, then click “Next” to continue.

EDIMAX Wi-Fi Router

Please set your Wi-Fi network name (SSID) and Wi-Fi password.

Wi-Fi network name (2.4GHz):

Wi-Fi password (WPA2-AES):
(at least 8 characters)

Wi-Fi network name (5GHz):

Wi-Fi password (WPA2-AES):
(at least 8 characters)

[Back](#) [Next](#)

- 6.** A summary of your configuration will be displayed, as shown below. Check that all of the details are correct and then click “Next” to proceed.

EDIMAX Wi-Fi Router

Configuration is complete. It is recommended that you backup your settings, please click "Backup this configuration" to do so. Then click "Next" when you are ready to continue.

Internet Type : Dynamic IP

(2.4 GHz) Wi-Fi network name : edimax_2.4G_00000C
Wi-Fi password : edimax1234

(5 GHz) Wi-Fi network name : edimax_5G_00000E
Wi-Fi password : edimax1234

[Back](#) [Next](#)

 ***If you wish to backup the device’s settings, click “Backup this configuration” to open a new window and save your current configuration to a .txt file.***

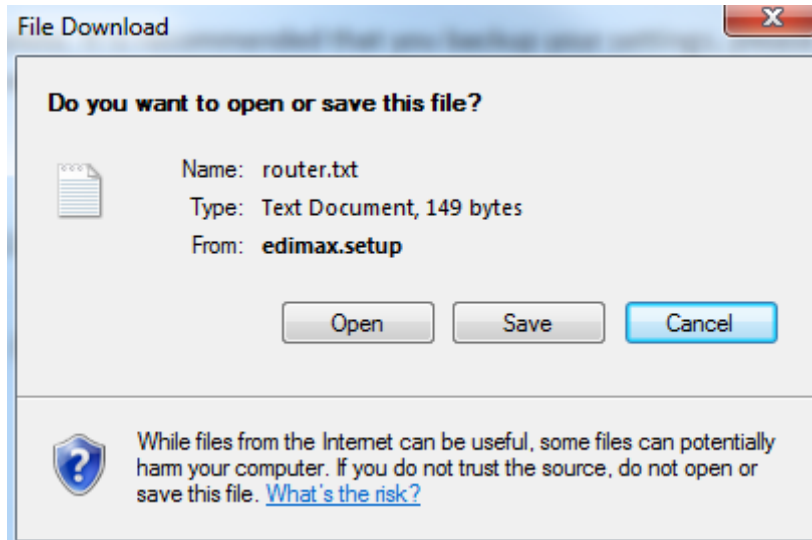

7. Please wait while the device applies your settings.

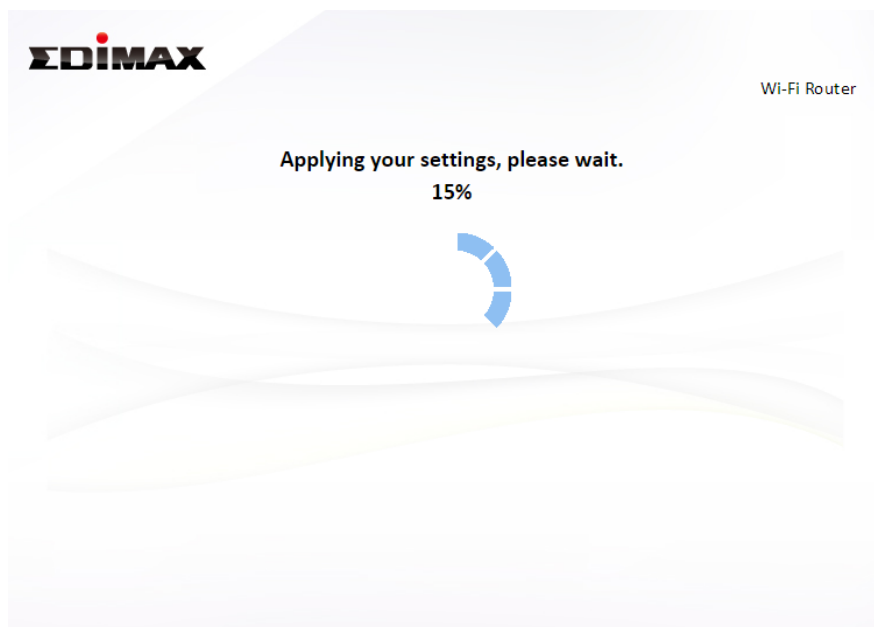

8. A final congratulations screen will indicate that setup is complete. You can now connect to the device's new SSID(s) which are shown on the screen then close the browser window.

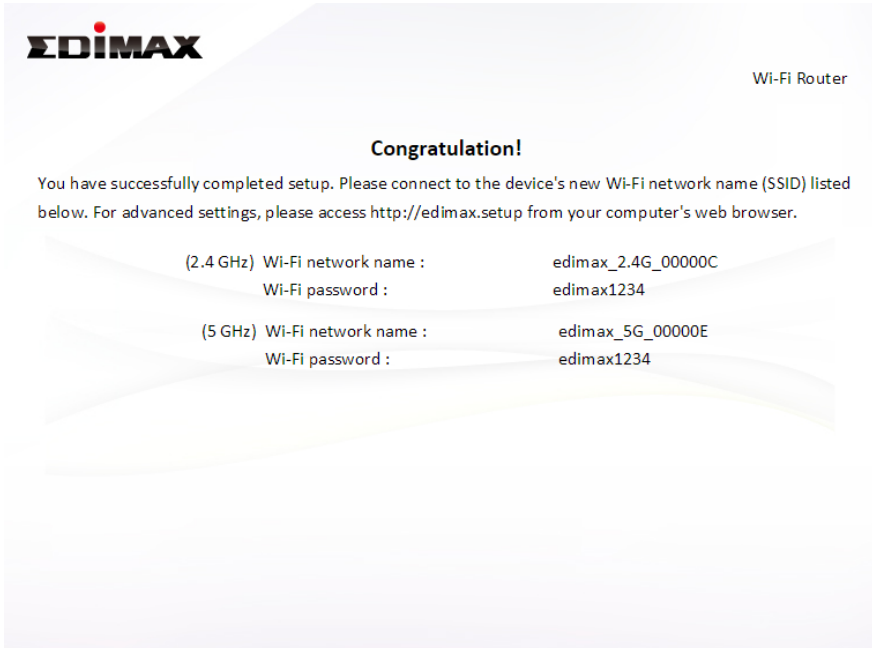

9. The BR-6478AC V2 is working and ready for use. Refer to [IV-2. Connecting to a Wi-Fi network](#) if you require more guidance.

II-2. Access Point Mode

1. Select “Access Point” from the top menu and click “Next”.

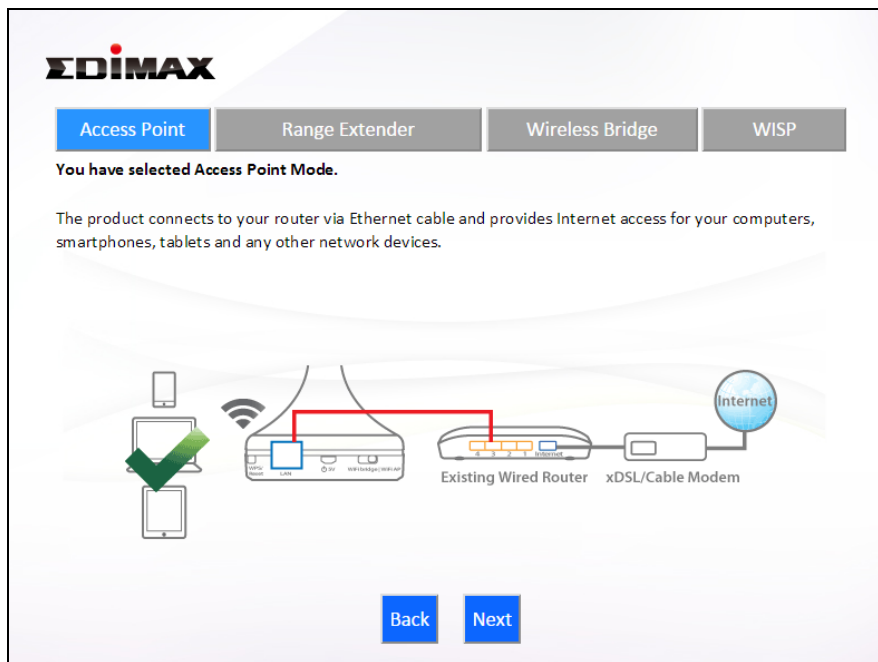

2. Connect the network port of your BR-6478 AC V2 to the LAN port of your existing router using an Ethernet cable, then click “Next”.

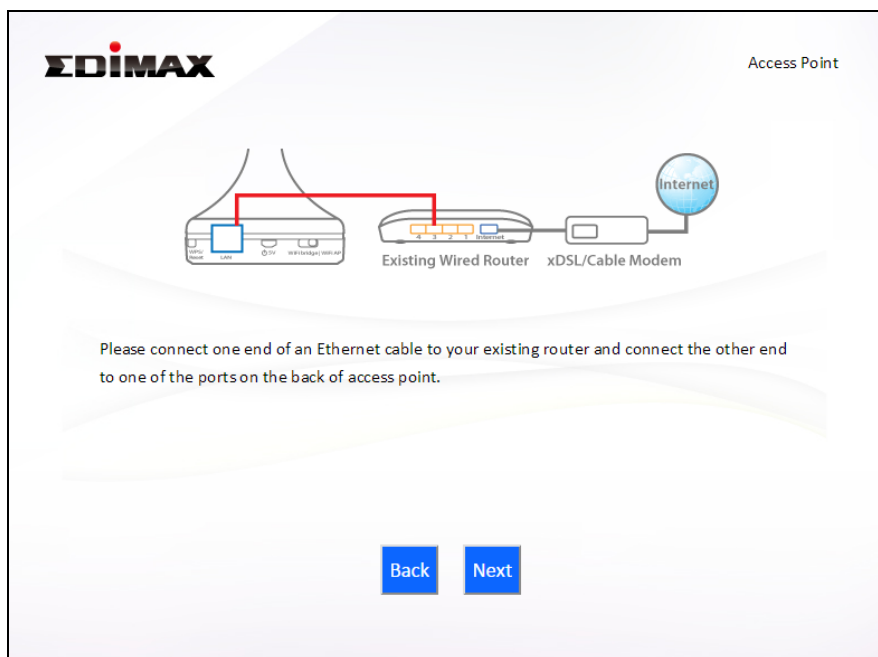

3. Select whether to use the 5GHz wireless frequency, 2.4GHz wireless frequency or both. If you are not sure, select both.

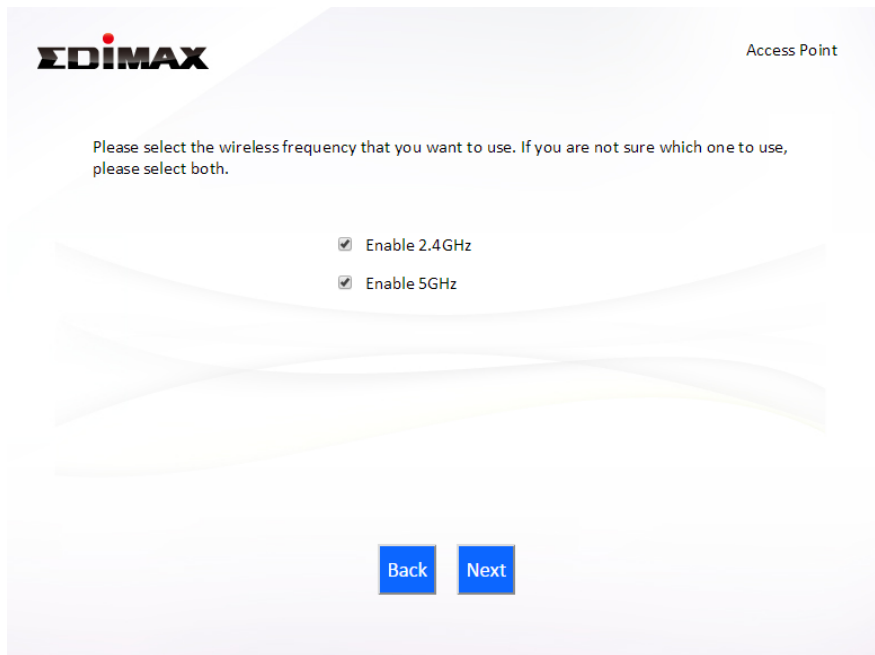

4. Select “Obtain an IP address automatically” or “Use the following IP address” for your BR-6478 AC V2. If you are using a static IP, enter the IP address, subnet mask and default gateway. Click “Next” to proceed to the next step.

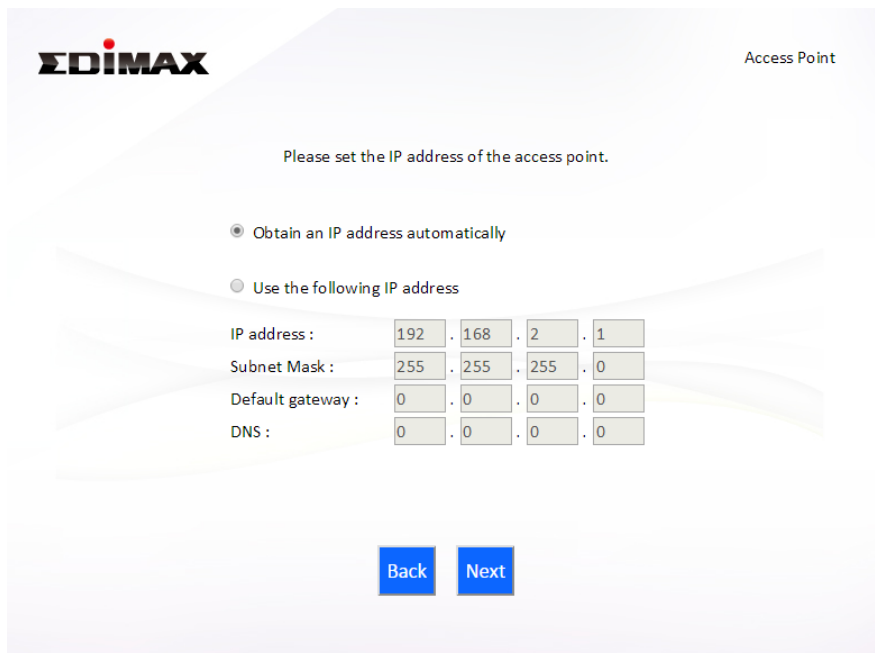

“Obtain an IP address automatically” is the recommended setting for most users. For more guidance on static IP addresses, please refer to [IV-1. Configuring your IP address.](#)

5. Enter a name and password for your 2.4GHz & 5GHz wireless networks, then click “Next” to continue.

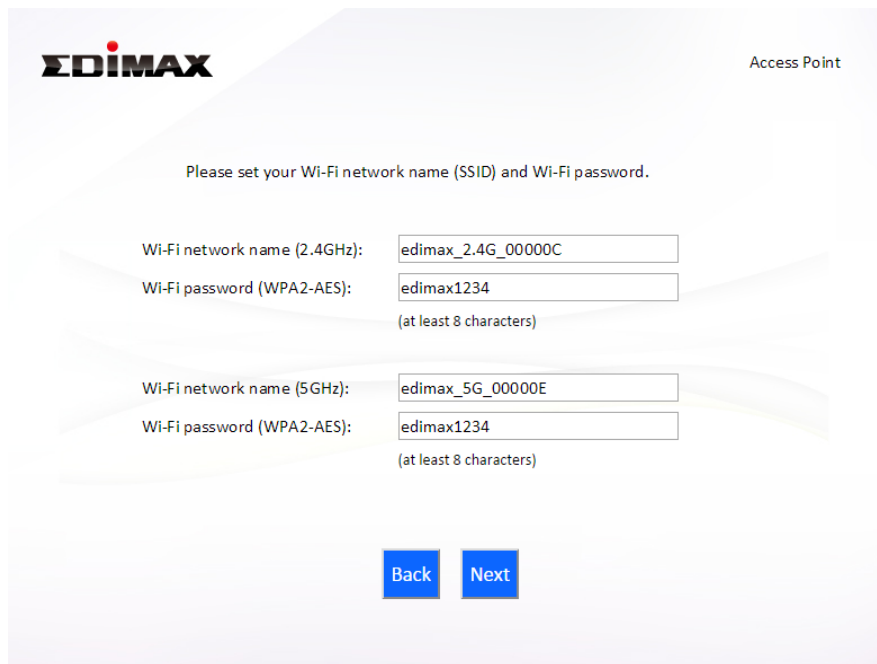

The screenshot shows the EDIMAX Access Point configuration interface. At the top left is the EDIMAX logo, and at the top right is the text "Access Point". Below the logo, a message reads: "Please set your Wi-Fi network name (SSID) and Wi-Fi password." There are two sets of input fields. The first set is for the 2.4GHz network, with the label "Wi-Fi network name (2.4GHz):" and the value "edimax_2.4G_00000C" in the text box, and "Wi-Fi password (WPA2-AES):" with the value "edimax1234" in the text box, and a note "(at least 8 characters)" below it. The second set is for the 5GHz network, with the label "Wi-Fi network name (5GHz):" and the value "edimax_5G_00000E" in the text box, and "Wi-Fi password (WPA2-AES):" with the value "edimax1234" in the text box, and a note "(at least 8 characters)" below it. At the bottom center, there are two blue buttons labeled "Back" and "Next".

6. A summary of your configuration will be displayed, as shown below. Check that all of the details are correct and then click “Next” to proceed.

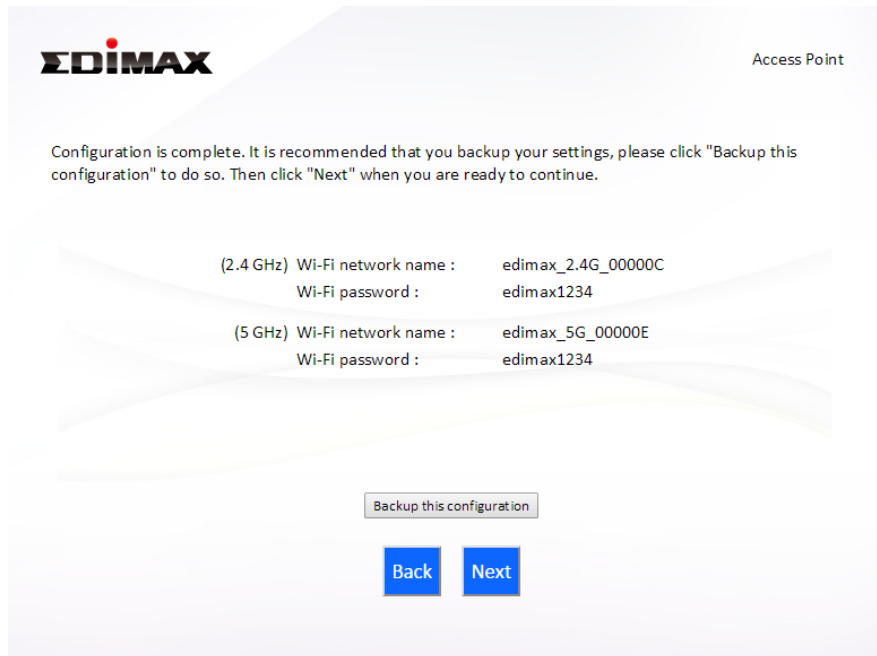

The screenshot shows the EDIMAX Access Point configuration interface displaying a summary of the configuration. At the top left is the EDIMAX logo, and at the top right is the text "Access Point". Below the logo, a message reads: "Configuration is complete. It is recommended that you backup your settings, please click "Backup this configuration" to do so. Then click "Next" when you are ready to continue." Below this message, there is a summary of the configuration: "(2.4 GHz) Wi-Fi network name : edimax_2.4G_00000C" and "Wi-Fi password : edimax1234", and "(5 GHz) Wi-Fi network name : edimax_5G_00000E" and "Wi-Fi password : edimax1234". At the bottom center, there is a button labeled "Backup this configuration" and two blue buttons labeled "Back" and "Next".



If you wish to backup the device’s settings, click “Backup this configuration” to open a new window and save your current configuration to a .txt file.

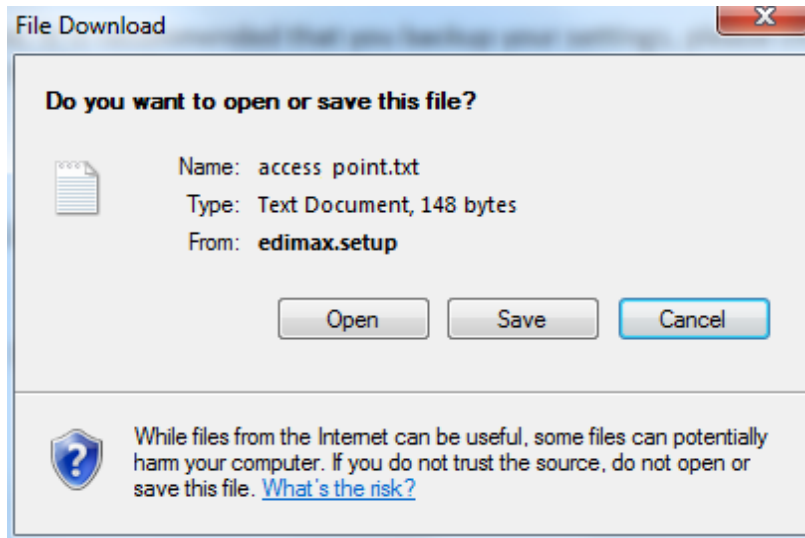

7. Please wait a moment until the BR-6478 AC V2 is ready.

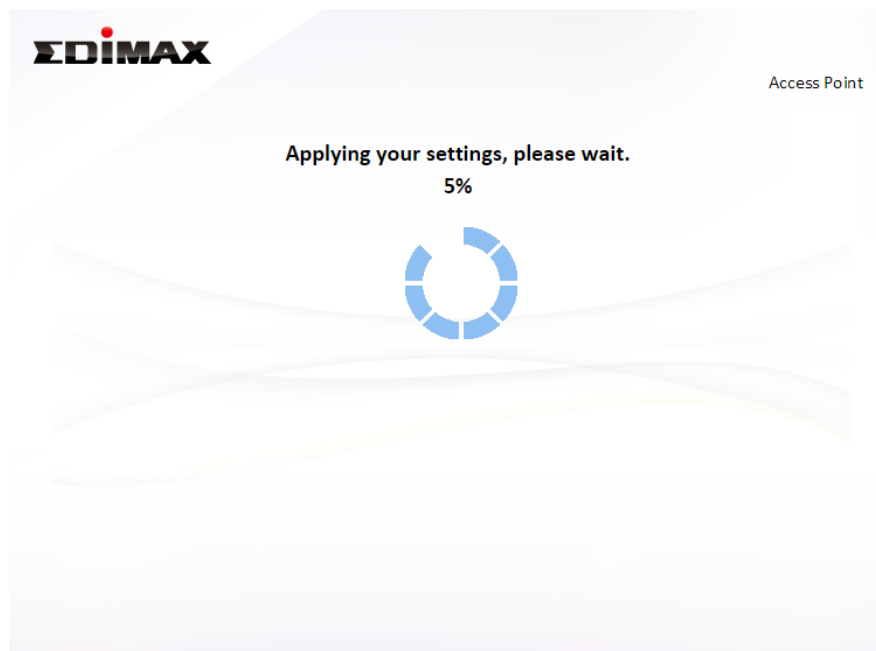

8. A final congratulations screen will indicate that setup is complete. You can now connect to the device's new SSID(s) which are shown on the screen then close the browser window.

Congratulation!

You have successfully completed setup. Please connect to the device's new Wi-Fi network name (SSID) listed below. For advanced settings, please access <http://edimax.setup> from your computer's web browser.

(2.4 GHz) Wi-Fi network name :	edimax_2.4G_00000C
Wi-Fi password :	edimax1234
(5 GHz) Wi-Fi network name :	edimax_5G_00000E
Wi-Fi password :	edimax1234

- 9.** The BR-6478 AC V2 is working and ready for use. Refer to [IV-2. Connecting to a Wi-Fi network](#) if you require more guidance.

II-3. Range Extender Mode

1. Select “Range Extender” from the top menu and click “Next”.

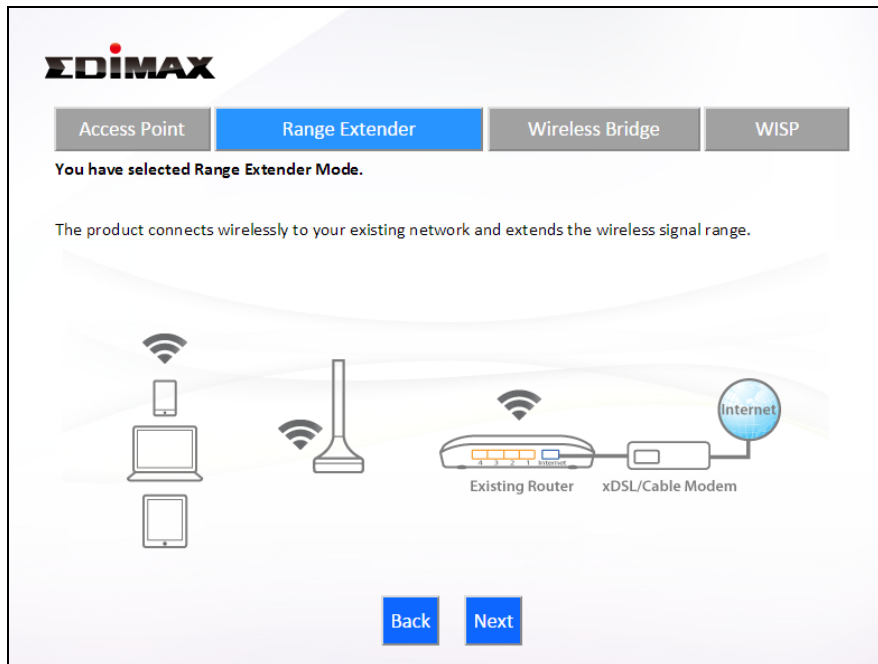

2. Please ensure your BR-6478 AC V2 is within Wi-Fi range of your existing wireless router. Click “Next” to continue.

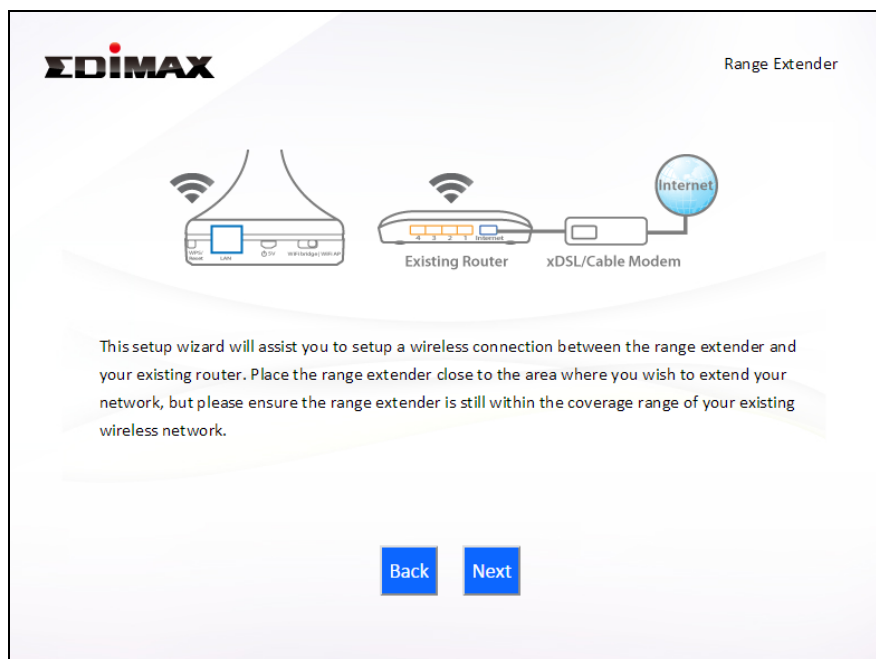

3. Select whether to use the 5GHz wireless frequency, 2.4GHz wireless frequency or both. If you are not sure, select both and then click “Next”.

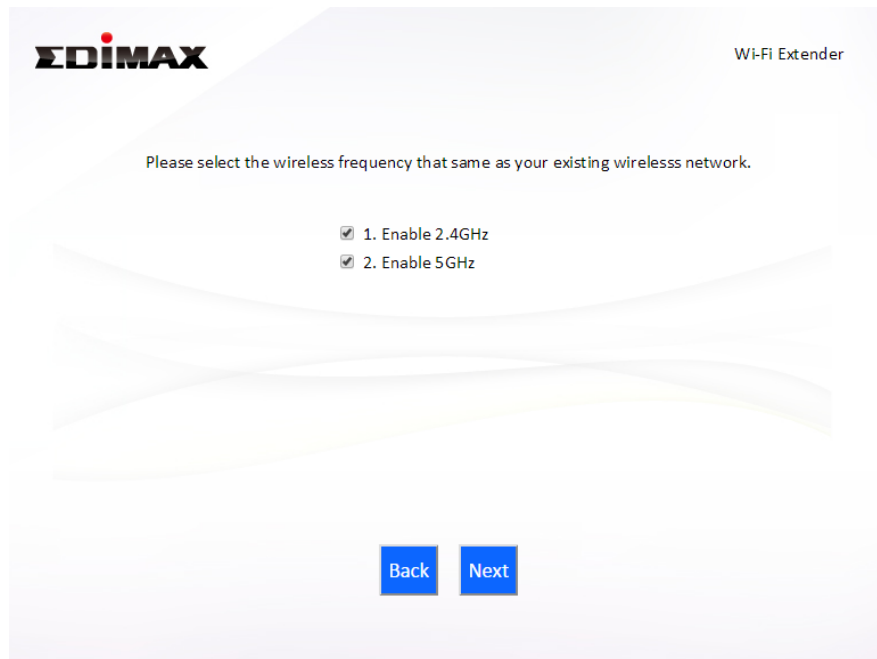

4. Select whether to enable Cross Band technology. This can help to maintain your router’s maximum speed capacity as the Wi-Fi signal is extended.

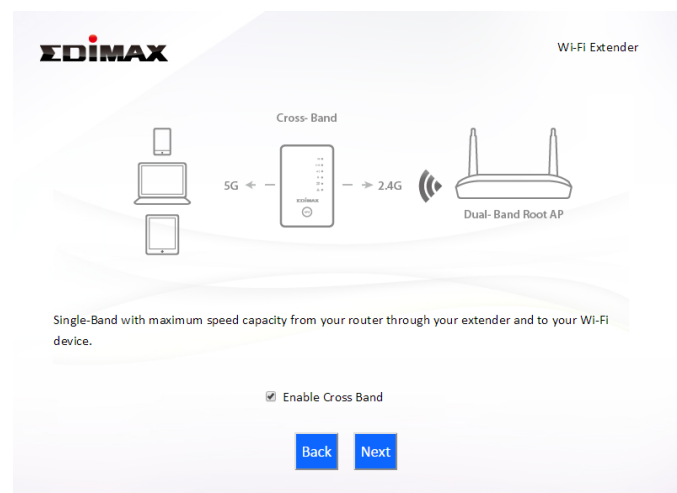
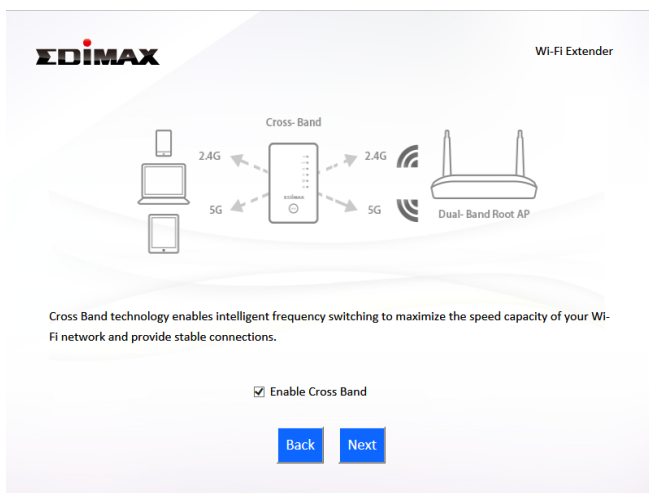

5. Select the Wi-Fi network name (SSID) which you wish to connect to for the specified frequency and click “Next” to continue.



If the Wi-Fi network you wish to connect to does not appear, try clicking “Refresh”.

EDIMAX Wi-Fi Extender

2.4GHz Wireless Site Survey

The range extender is surveying all available routers nearby. Please select the router you wish to connect to. If the router you wish to connect is not listed, try clicking "Refresh". To connect to a hidden SSID please select "Setup extender manually".

Setup extender manually

Select	SSID	Signal
<input type="radio"/>	chichi	96 %
<input type="radio"/>	matt	76 %
<input type="radio"/>	JackWAP	44 %
<input type="radio"/>	DIRECT-V8-BRAVIA	39 %
<input type="radio"/>	max866799	34 %
<input type="radio"/>	Jackchen	15 %



To connect to a hidden SSID, check the “Setup extender manually” box and enter the details manually on the next page, as shown below.

EDIMAX Wi-Fi Extender

2.4GHz Wireless Site Survey

Please set a new Wi-Fi network name (SSID) for the range extender if you wish, and set the security key for your existing wireless network if required.

Wi-Fi network name (SSID):

Range extender SSID:

Hide SSID Enable

Encryption: WPA2

Security Type: TKIP AES

Key Format: Passphrase

Wi-Fi password (Security Key):

- Enter your existing wireless network’s security key/password in the “Security Key” field and click “Next” to continue.



Device SSID will be the SSID of your extender’s Wi-Fi. If using cross-band technology this will be 5GHz Wi-Fi for your router’s 2.4GHz signal and vice versa.

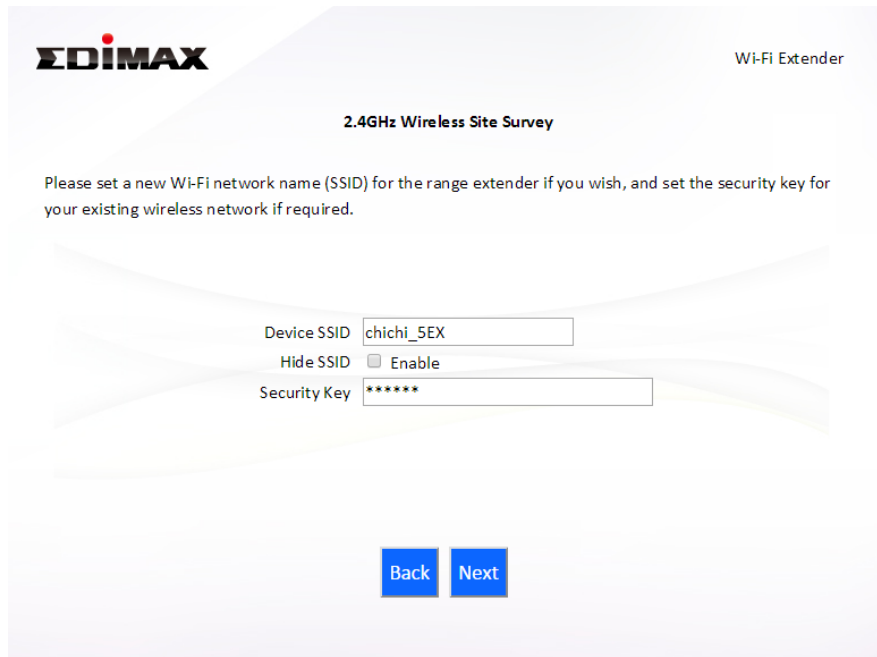

7. Wait a moment while the BR-6478 AC V2 tests the wireless connection.

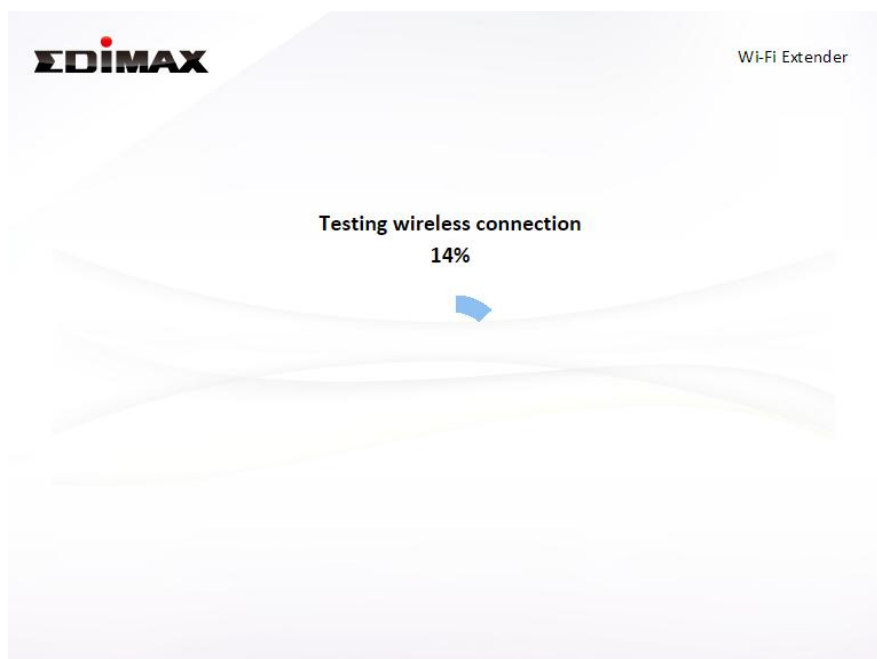

8. Select “Obtain an IP address automatically” or “Use the following IP address” for your BR-6478 AC V2. If you are using a static IP, enter the IP address, subnet mask and default gateway. Click “Next” to proceed to the next step.

 ***“Obtain an IP address automatically” is the recommended setting for most users. The IP address will be displayed in brackets.***

EDIMAX Wi-Fi Extender

Connection test complete. Please click "Next" when you are ready to continue.

Obtain an IP address automatically
 (IP : 192.168.0.107)

Use the following IP address

IP address : . . .

Subnet Mask : . . .

Default gateway : . . .

DNS : . . .

9. If you selected to use both 2.4GHz and 5GHz wireless frequencies in step 3, then repeat **steps 4 – 7** for the 2.4GHz wireless frequency.

EDIMAX Wi-Fi Extender

5GHz Wireless Site Survey

The range extender is surveying all available routers nearby. Please select the router you wish to connect to. If the router you wish to connect is not listed, try clicking "Refresh". To connect to a hidden SSID please select "Setup extender manually".

Setup extender manually

Select	SSID	Signal
<input type="radio"/>	chichi5	47 %

10. A summary of your configuration will be displayed, as shown below. Check that all of the details are correct and then click "Next" to proceed.



The device will use the same wireless password/security key as the existing wireless network.

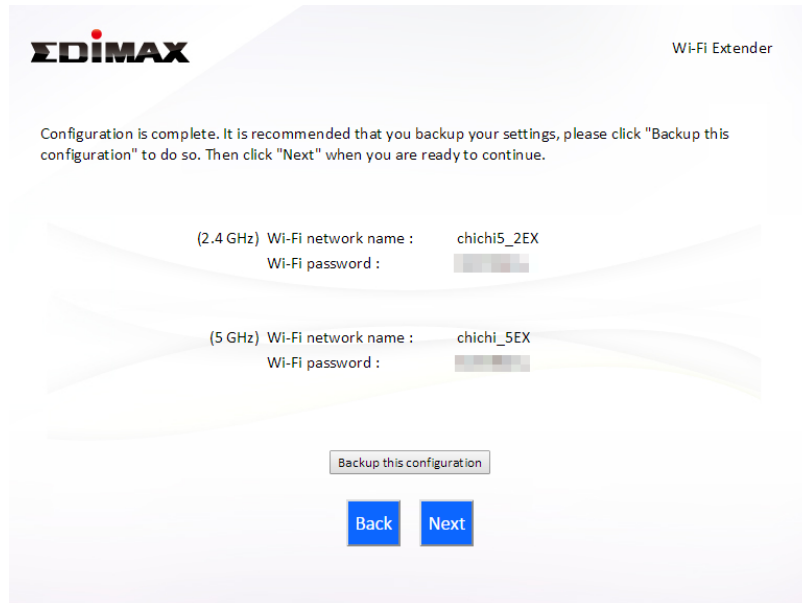

 ***If you wish to backup the BR-6478 AC V2's settings, click "Backup this configuration" to open a new window and save your current configuration to a .txt file.***

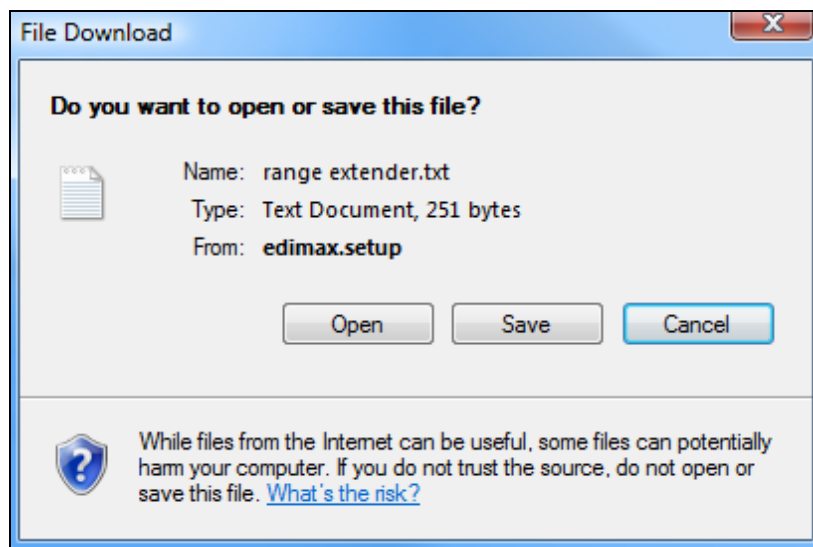

11. Please wait a moment until the BR-6478 AC V2 is ready.

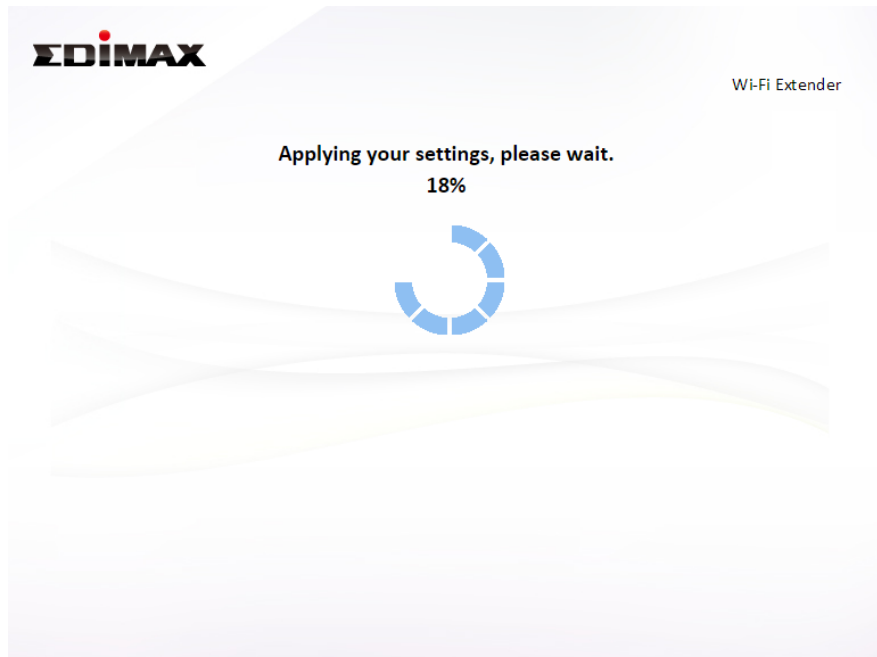

- 12.** A final congratulations screen will indicate that setup is complete. You can now connect to the device's new SSID(s) which are shown on the screen then close the browser window.

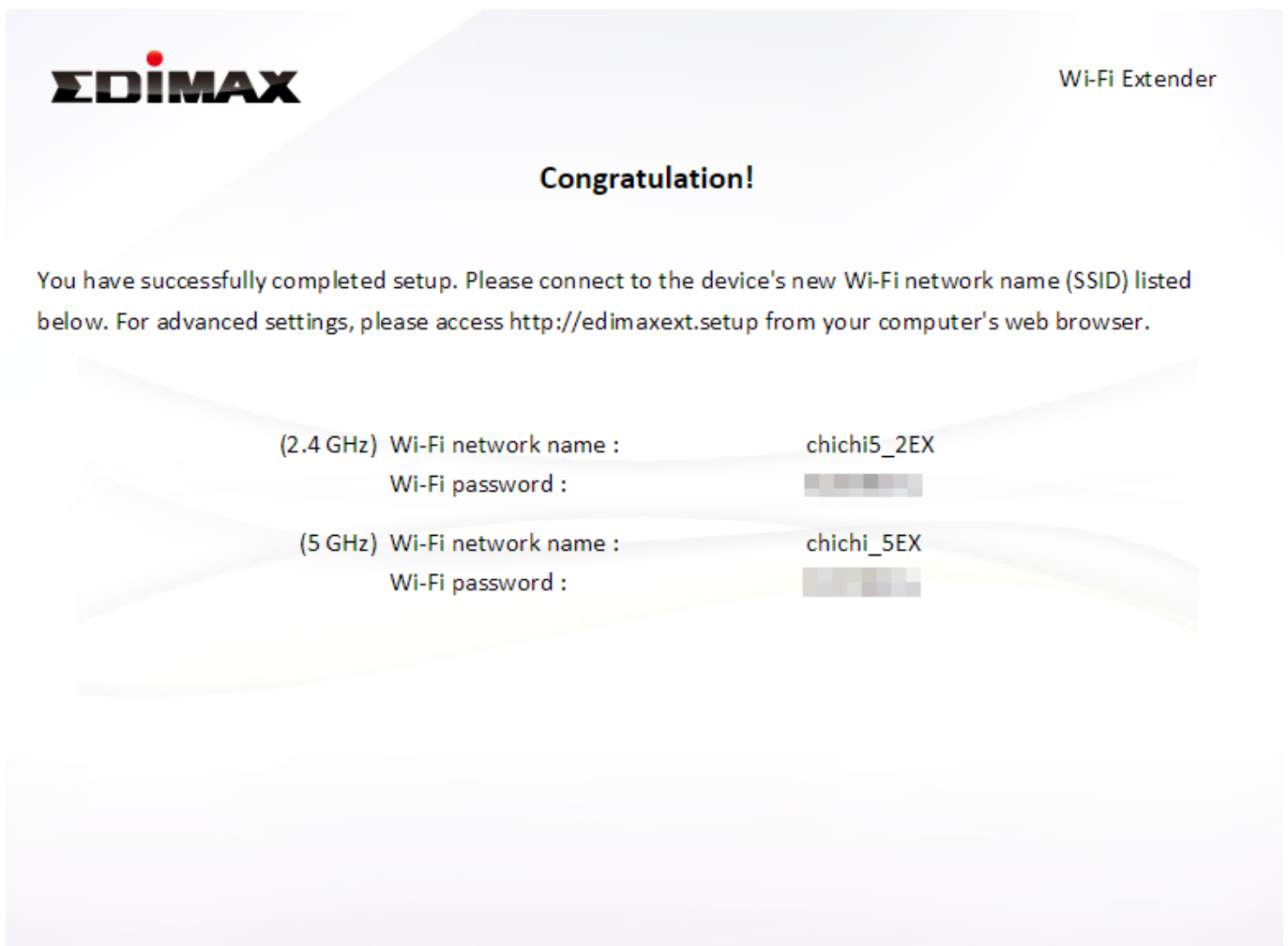

13. The BR-6478 AC V2 is working and ready for use. Refer to [IV-2. Connecting to a Wi-Fi network](#) if you require more guidance.

II-4. Wireless Bridge Mode

1. Select “Wireless Bridge” from the top menu and click “Next”.

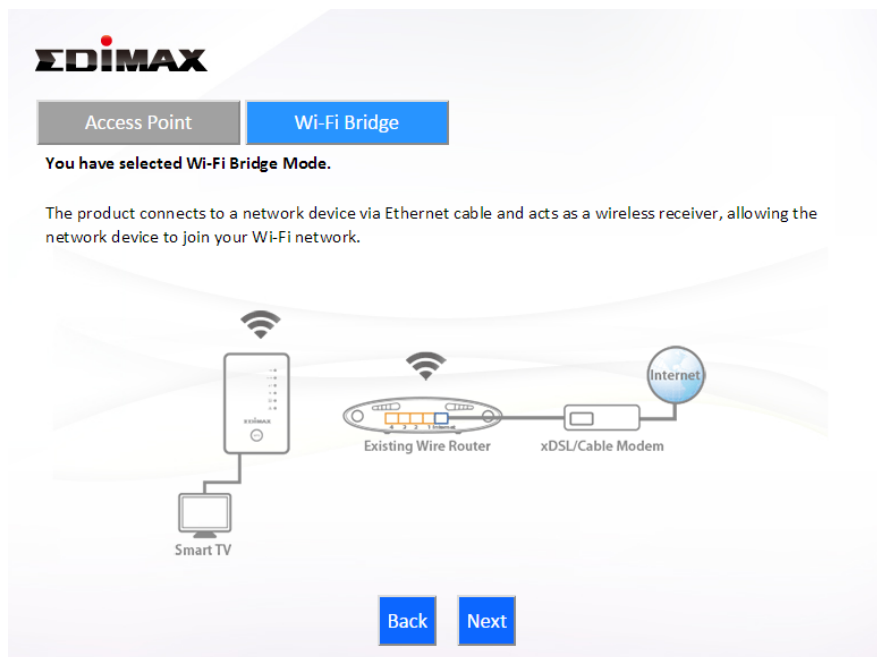

2. Please ensure your BR-6478 AC V2 is within Wi-Fi range of your existing wireless router. Click “Next” to continue.



3. Select the frequency (2.4GHz or 5GHz) of your existing wireless network.



In wireless client mode, the BR-6478 AC V2 can only connect to one wireless network/frequency i.e. 2.4GHz or 5GHz.

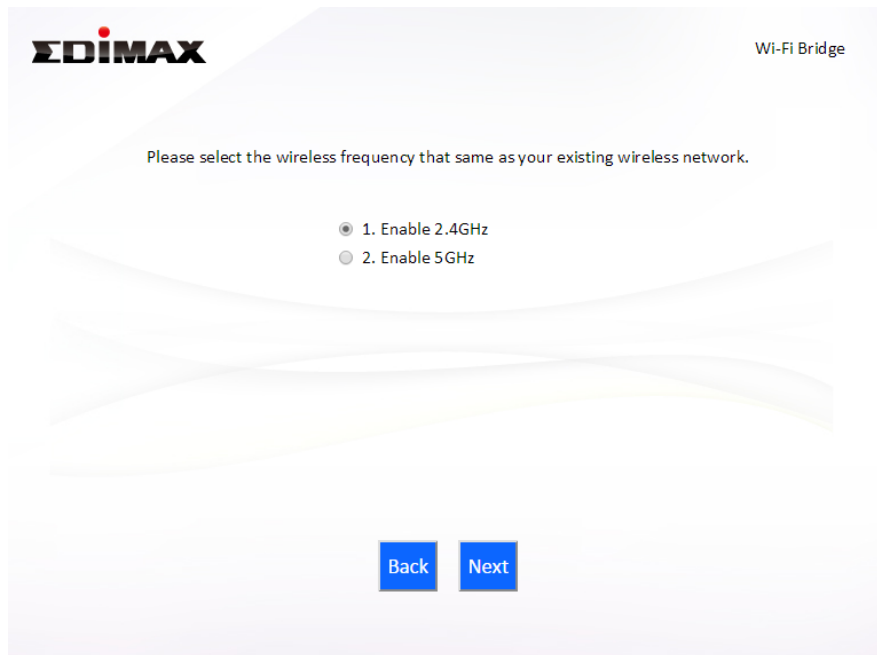

4. Select the Wi-Fi network name (SSID) which you wish to connect to and click “Next” to continue.



If the Wi-Fi network you wish to connect to does not appear, try clicking “Refresh”.

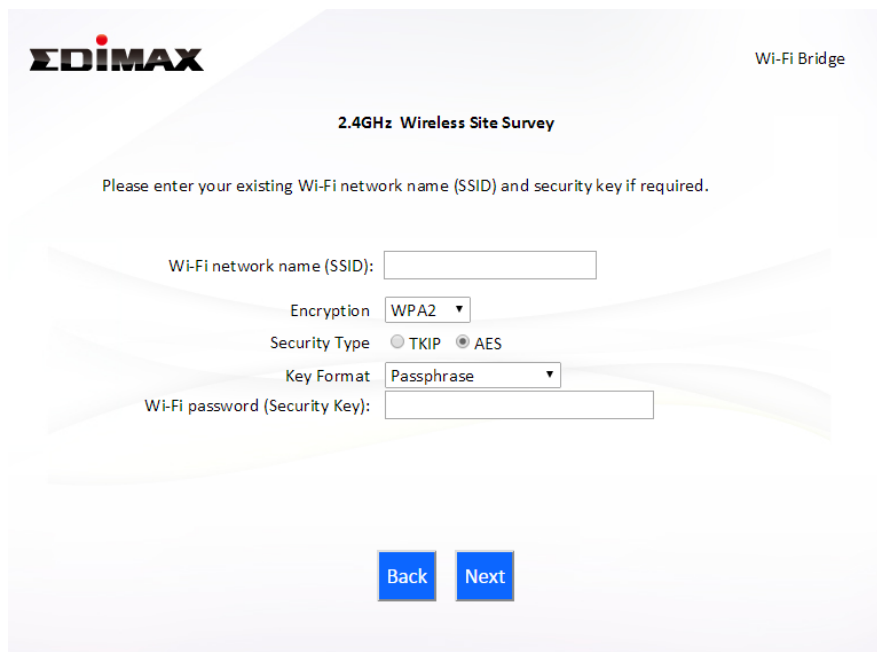

To connect to a hidden SSID, check the “Setup extender manually” box and enter the details manually on the next page, as shown below.

5. Enter your existing wireless network's security key/password in the "Security Key" field and click "Next" to continue.

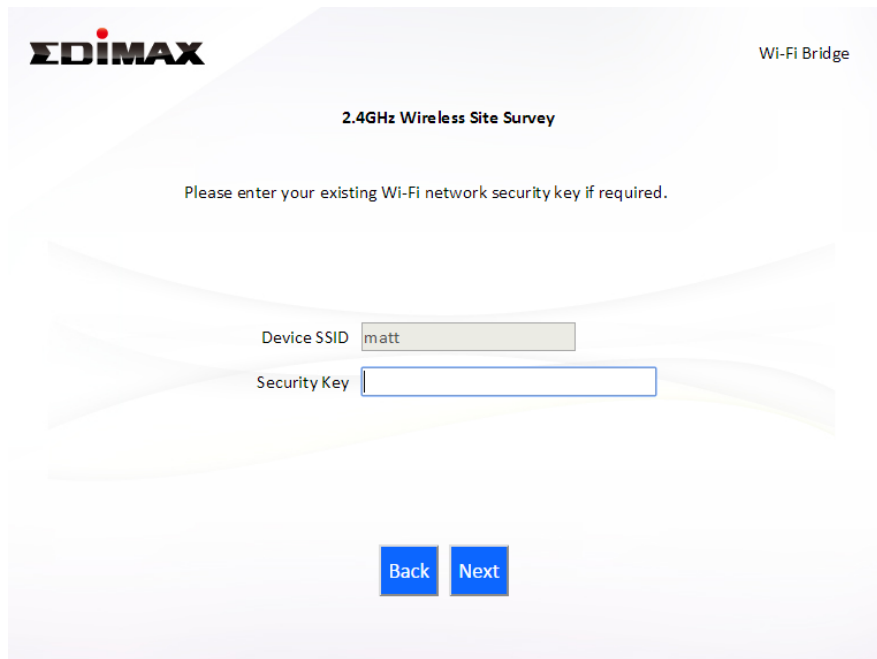

EDIMAX Wi-Fi Bridge

2.4GHz Wireless Site Survey

Please enter your existing Wi-Fi network security key if required.

Device SSID

Security Key

[Back](#) [Next](#)

6. Wait a moment while the BR-6478 AC V2 tests the wireless connection.

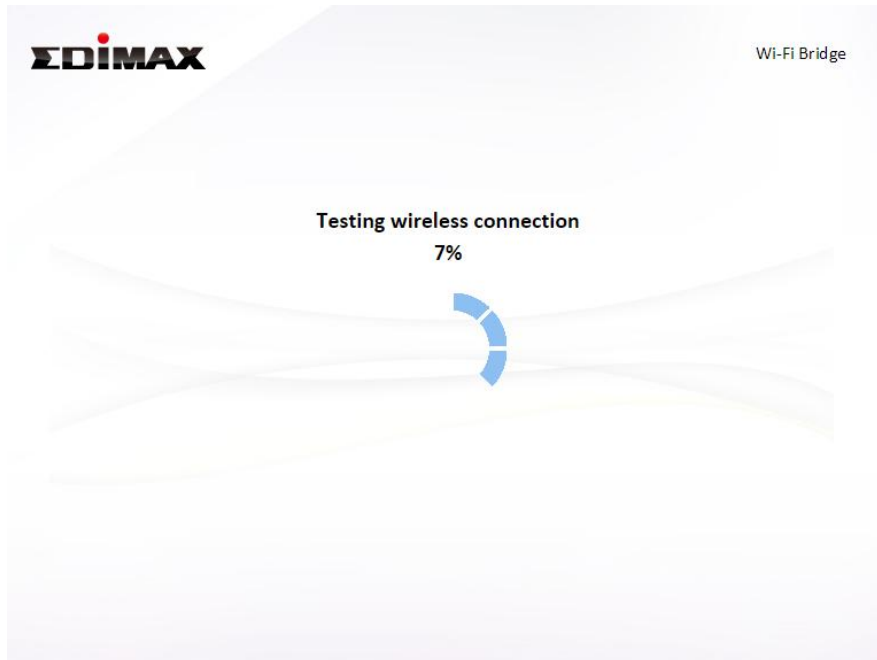

7. Select "Obtain an IP address automatically" or "Use the following IP address" for your BR-6478 AC V2. If you are using a static IP, enter the IP address, subnet mask and default gateway. Click "Next" to proceed to the next step.

 **“Obtain an IP address automatically” is the recommended setting for most users. The IP address will be displayed in brackets.**



The screenshot shows the EDIMAX Wi-Fi Bridge configuration interface. At the top left is the EDIMAX logo, and at the top right is the text "Wi-Fi Bridge". Below the logo, a message states: "Connection test complete. Please click 'Next' when you are ready to continue." There are two radio button options: "Obtain an IP address automatically (IP : 192.168.0.107)" which is selected, and "Use the following IP address". Below these options are four rows of input fields for IP address, Subnet Mask, Default gateway, and DNS, each with four individual input boxes. The values are: IP address: 192, 168, 2, 1; Subnet Mask: 255, 255, 255, 0; Default gateway: 0, 0, 0, 0; DNS: 0, 0, 0, 0. At the bottom are two blue buttons labeled "Back" and "Next".

- 8.** A summary of your configuration will be displayed, as shown below. Check that all of the details are correct and then click “Next” to proceed.

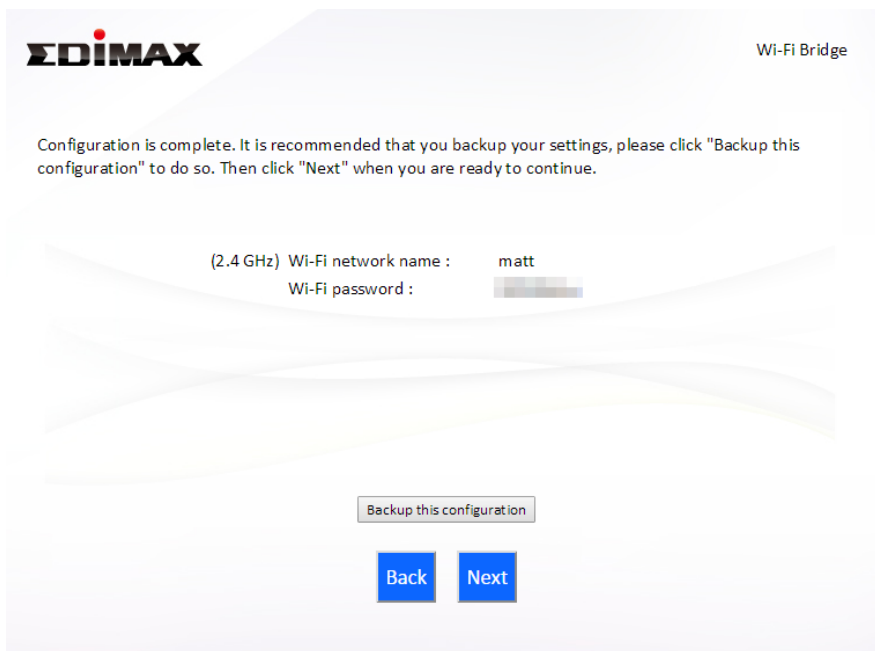

The screenshot shows the EDIMAX Wi-Fi Bridge configuration interface. At the top left is the EDIMAX logo, and at the top right is the text "Wi-Fi Bridge". Below the logo, a message states: "Configuration is complete. It is recommended that you backup your settings, please click 'Backup this configuration' to do so. Then click 'Next' when you are ready to continue." Below this message, there are two lines of text: "(2.4 GHz) Wi-Fi network name : matt" and "Wi-Fi password : [blacked out]". At the bottom, there is a button labeled "Backup this configuration" and two blue buttons labeled "Back" and "Next".

 **If you wish to backup the BR-6478 AC V2’s settings, click “Backup this configuration” to open a new window and save your current configuration to a .txt file.**

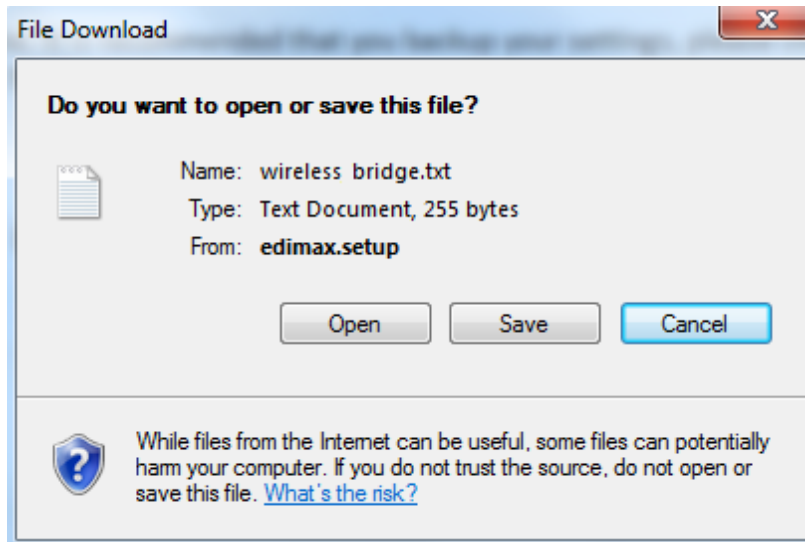

9. Please wait a moment until the BR-6478 AC V2 is ready.

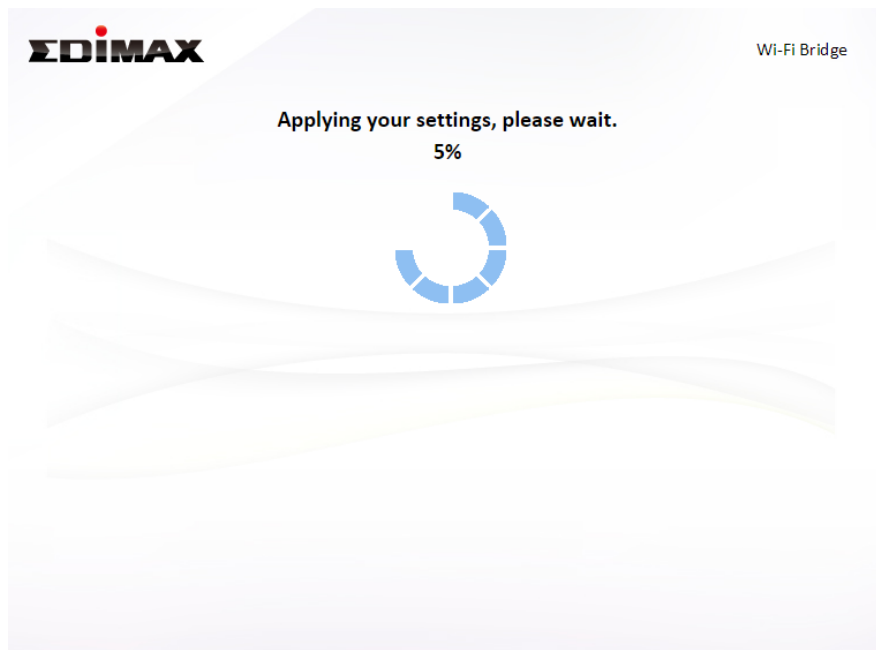

10. A final congratulations screen will indicate that setup is complete. Please close the browser window.

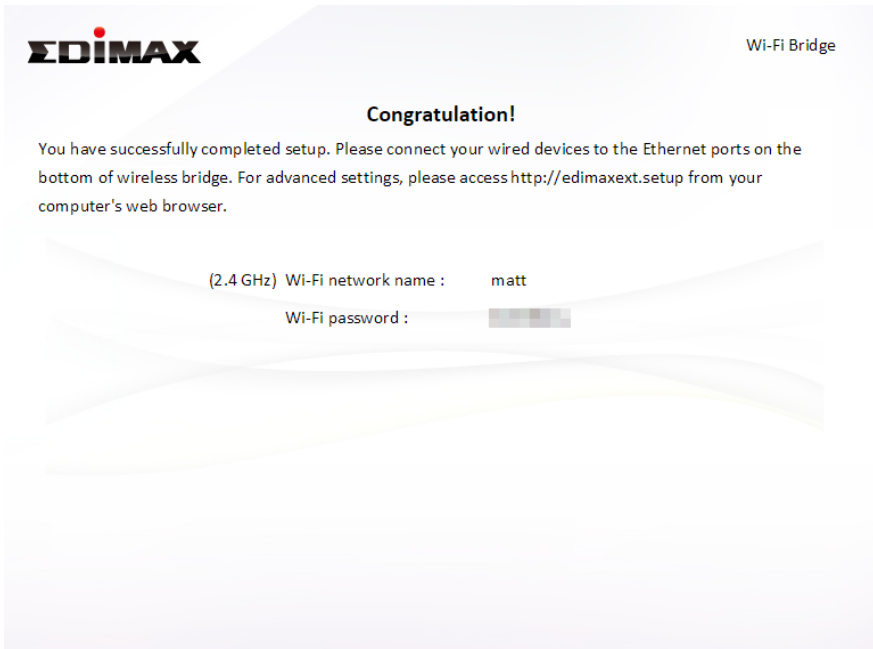

- 11.** The BR-6478 AC V2 is working and ready for use. You can now connect the BR-6478 AC V2 to your network device using an Ethernet cable and connect to your network as usual.

II-5. WISP Mode

1. Select “WISP” from the top menu and click “Next”.

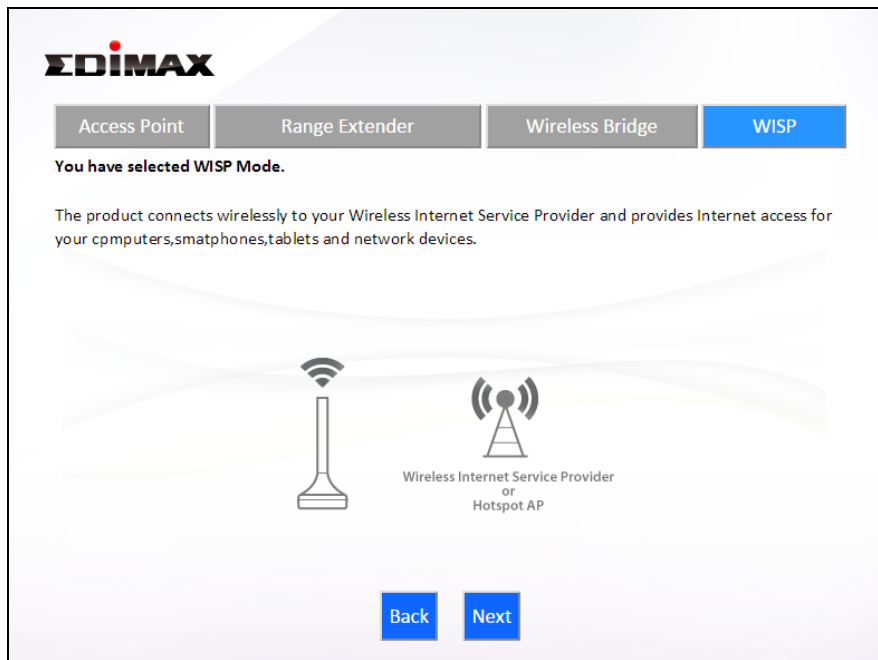

2. Please ensure your BR-6478 AC V2 is within Wi-Fi range of your WISP network and click “Next” to continue.

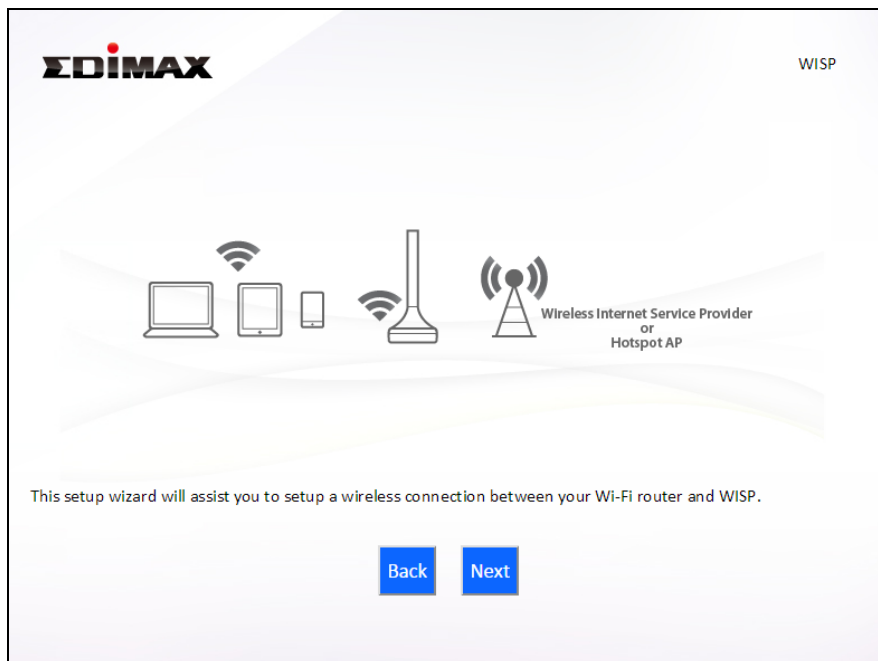

3. Select whether to use the iQ Setup wizard (recommended) to detect your Internet connection type, or enter the settings manually.



Manual configuration is only recommended for advanced users.

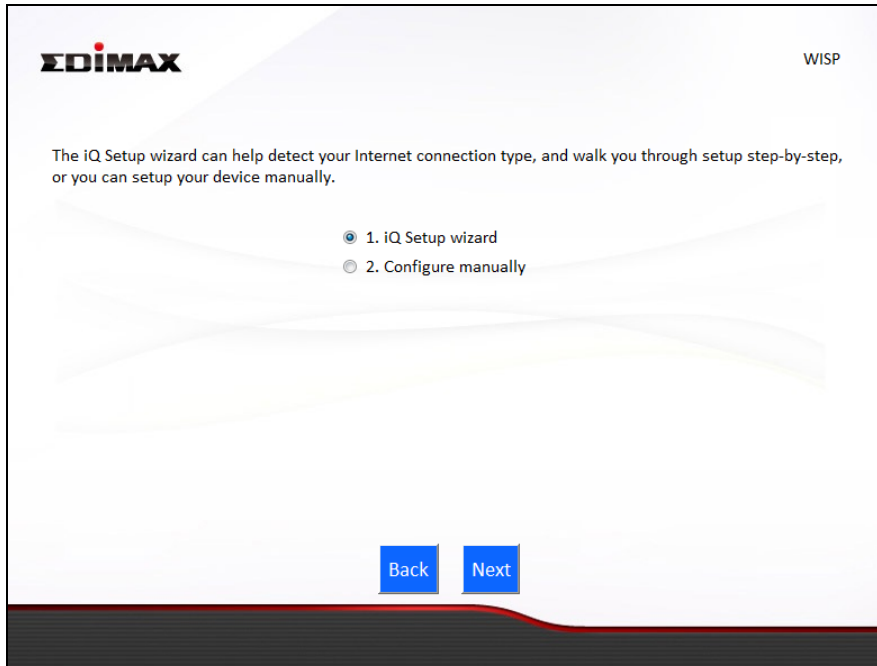

4. Select the wireless frequency (2.4GHz or 5GHz) of your WISP network.

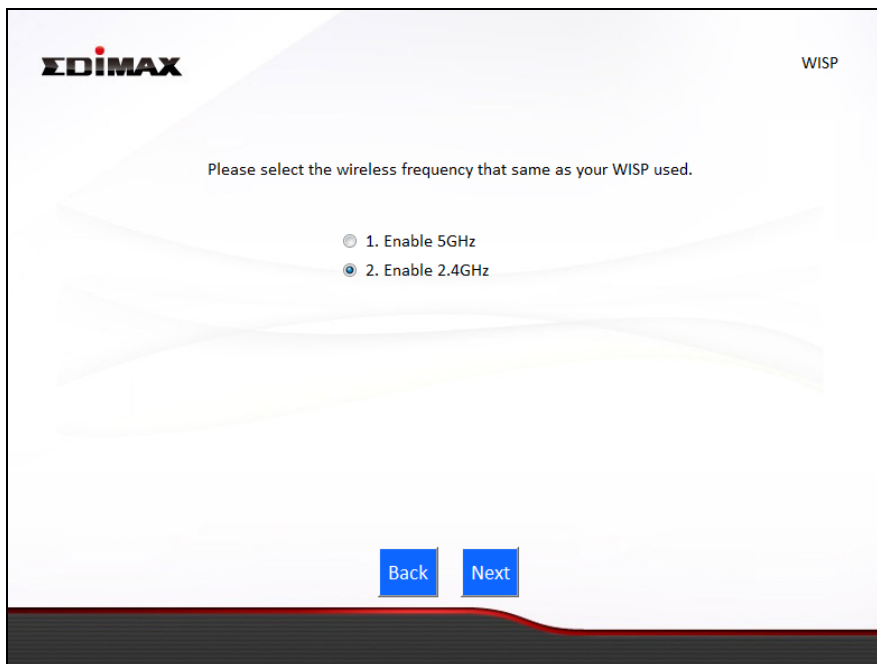

5. Select the WISP SSID which you wish to connect to and click “Next” to continue.



If the Wi-Fi network you wish to connect to does not appear, try clicking “Refresh”.

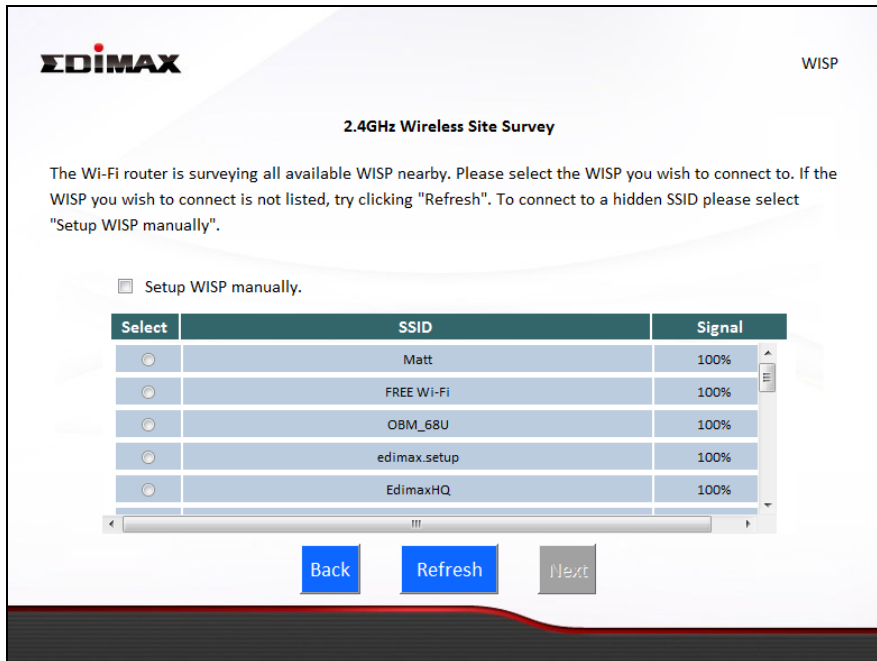

 **To connect to a hidden SSID, check the “Setup extender manually” box and enter the details manually on the next page, as shown below.**

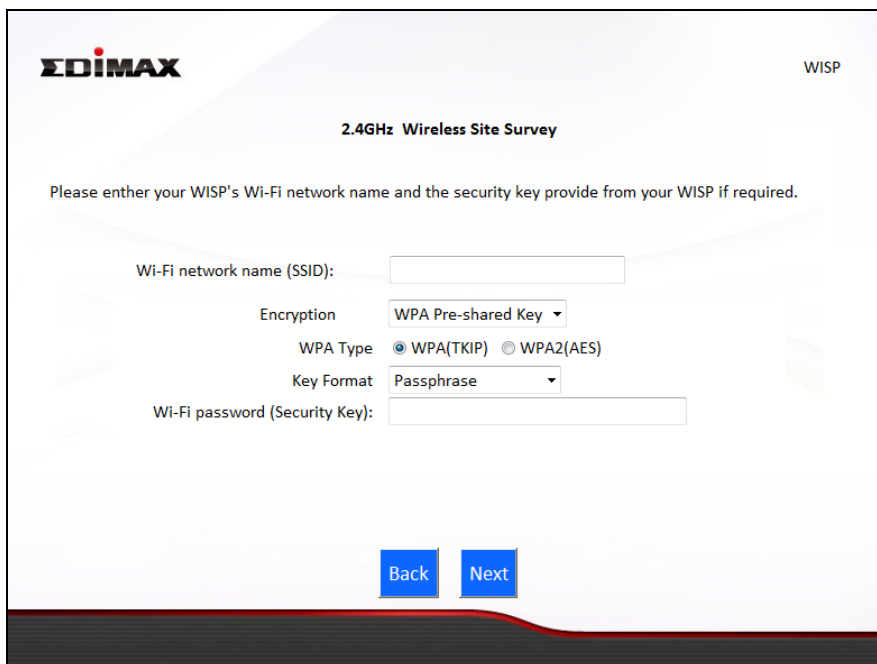

6. Enter your existing wireless network’s security key/password in the “Security Key” field and click “Next” to continue.

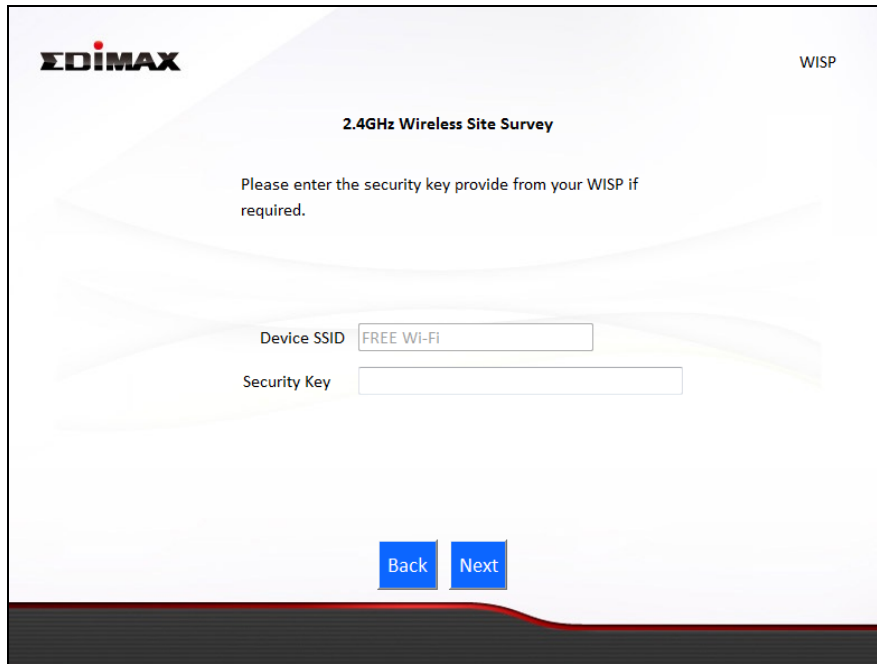

The image shows a web-based configuration interface for an EDIMAX device. At the top left is the EDIMAX logo, and at the top right is the text 'WISP'. The main heading is '2.4GHz Wireless Site Survey'. Below this, a message reads: 'Please enter the security key provide from your WISP if required.' There are two input fields: 'Device SSID' with the value 'FREE WI-FI' and 'Security Key' which is currently empty. At the bottom center, there are two blue buttons labeled 'Back' and 'Next'.

7. Wait a moment while the BR-6478 AC V2 tests the wireless connection.

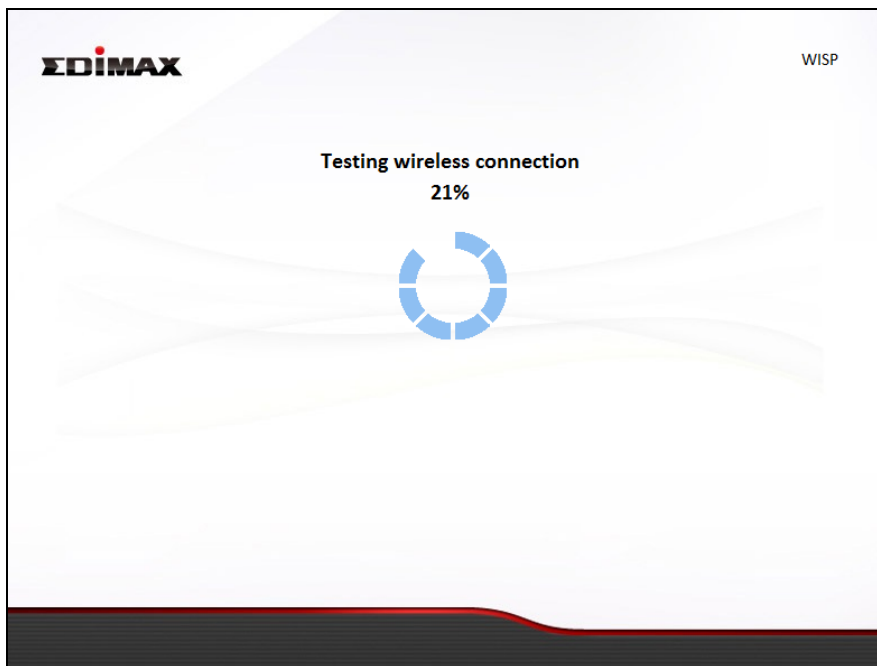

8. Click “Next” to continue your Internet service type configuration.

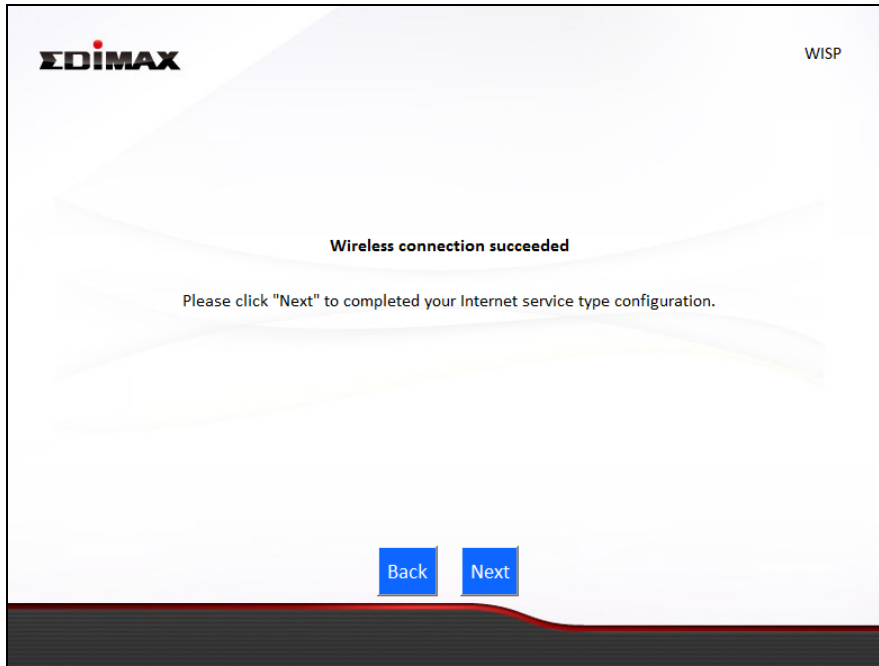

9. Wait a moment while the BR-6478 AC V2 connects to the Internet.

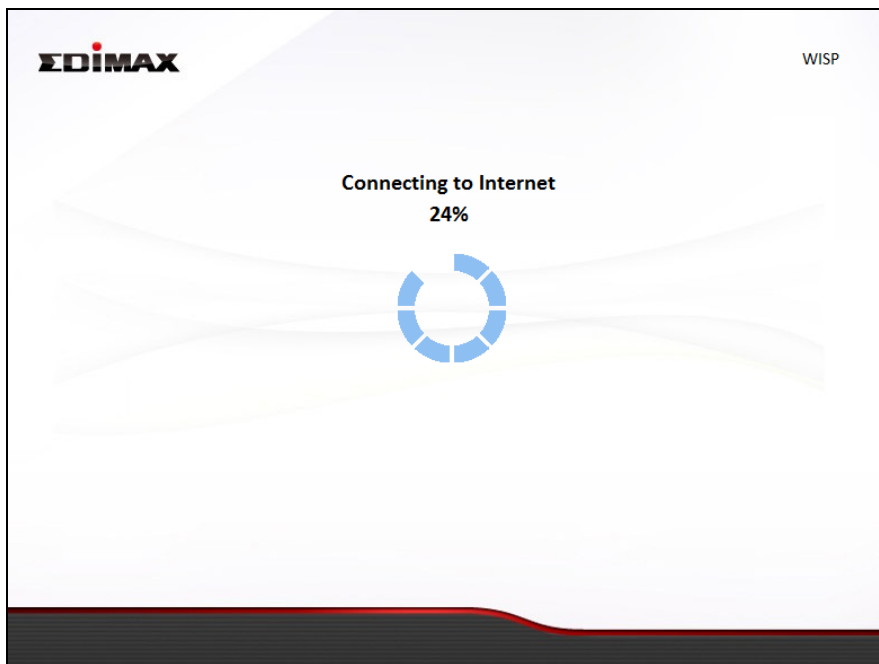

10. When the Internet is connected, click “Next” to configure your wireless network.

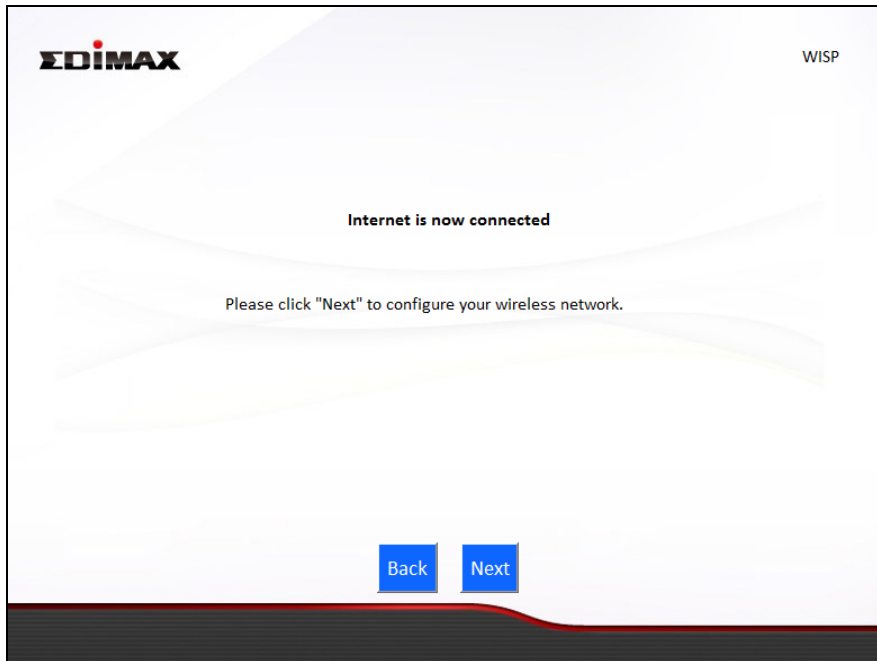

- 11.** Enter a name and password for your 2.4GHz & 5GHz wireless networks, then click “Next” to continue.

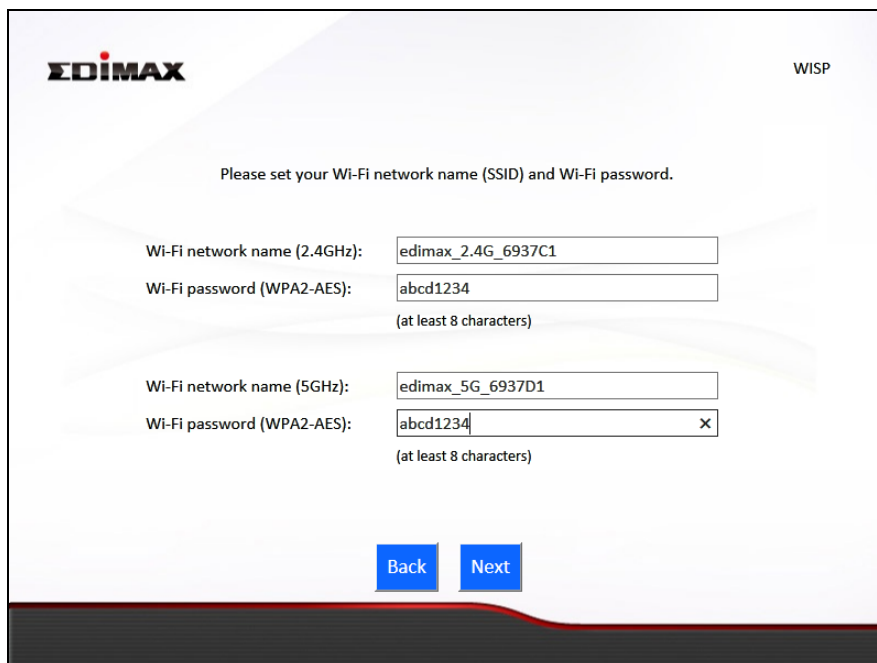

- 12.** A summary of your configuration will be displayed, as shown below. Check that all of the details are correct and then click “Next” to proceed.

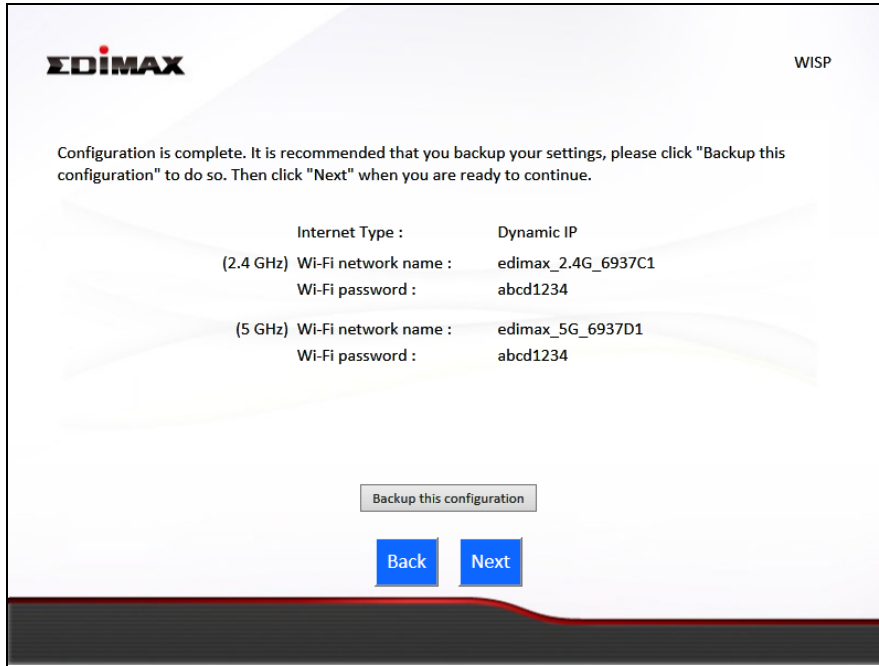

 ***If you wish to backup the device's settings, click "Backup this configuration" to open a new window and save your current configuration to a .txt file.***

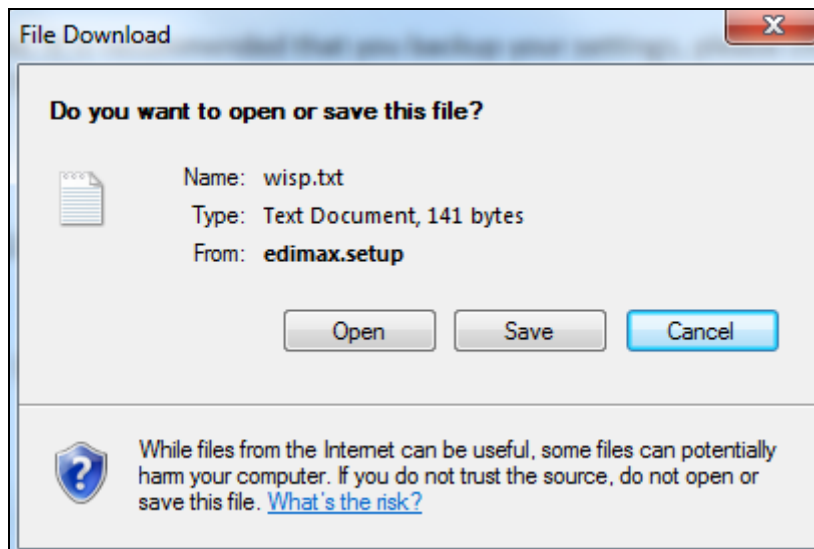

13. Please wait a moment until the BR-6478 AC V2 is ready.

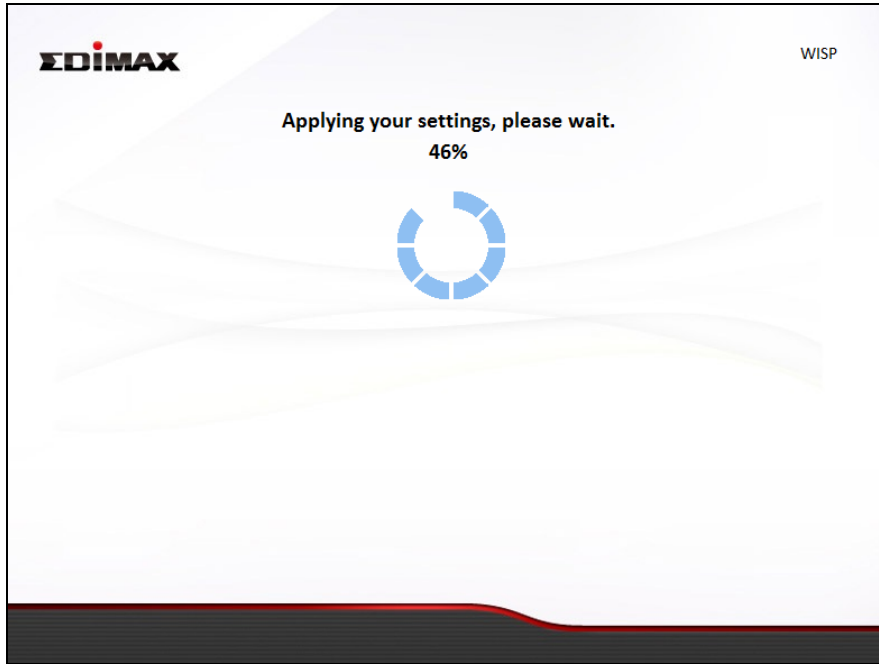

14. A final congratulations screen will indicate that setup is complete. You can now connect to the device's new SSID(s) which are shown on the screen then close the browser window.

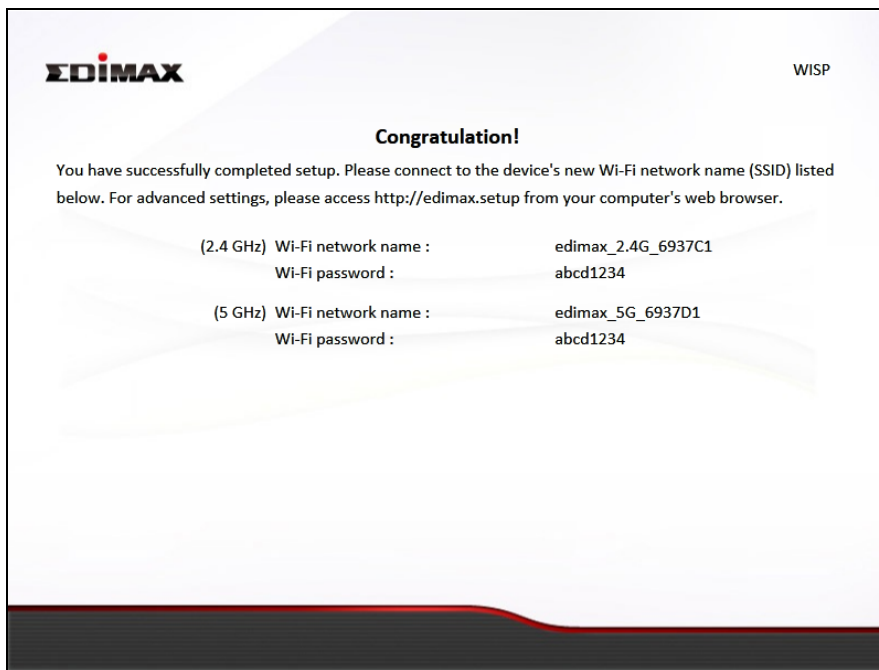

15. The BR-6478 AC V2 is working and ready for use. Refer to [IV-2. Connecting to a Wi-Fi network](#) if you require more guidance.

II-6. WPS Setup

If your wireless device supports WPS (Wi-Fi Protected Setup) then you can use this method to connect to the BR-6478 AC V2's Wi-Fi network.

- 1.** Press the **WPS/Reset button** on the BR-6478 AC V2 for 2 seconds to activate WPS. The LED will then flash blue to indicate that WPS is active.
- 2.** **Within two minutes**, press the WPS button on the **wireless device/client** to activate its WPS.
- 3.** The devices will establish a connection. Repeat for additional wireless devices.



Please check the instructions for your wireless device for how long you need to hold down its WPS button to activate WPS.

II-7. Reset to Factory Default Settings

If you experience problems with your BR-6478 AC V2, you can reset the device back to its factory settings. This resets **all** settings back to default.

- 1.** Press and hold the **WPS/Reset button** found on the rear base of the product for at least 10 seconds.
- 2.** Release the button when the LED is flashing blue.
- 3.** Wait for the BR-6478 AC V2 to restart.

III. *Browser Based Configuration Interface*

After you have setup the BR-6478 AC V2 as detailed in **II. Installation** or the included **Quick Installation Guide**, you can use the browser based configuration interface to configure advanced settings.



Please ensure that your computer is set to use a dynamic IP address. Refer to [IV-1. Configuring your IP address](#) for more information.

III-1. Login

1. To access the browser based configuration interface enter ***http://edimax.setup*** into the URL bar of a browser on a network device connected to the same Wi-Fi network as the BR-6478 AC V2.



If you can not access [http://edimax.setup](#), connect the device to a computer using an Ethernet cable and try again.

2. You will be prompted for a username and password. The default username is “admin” and the default password is “1234”.

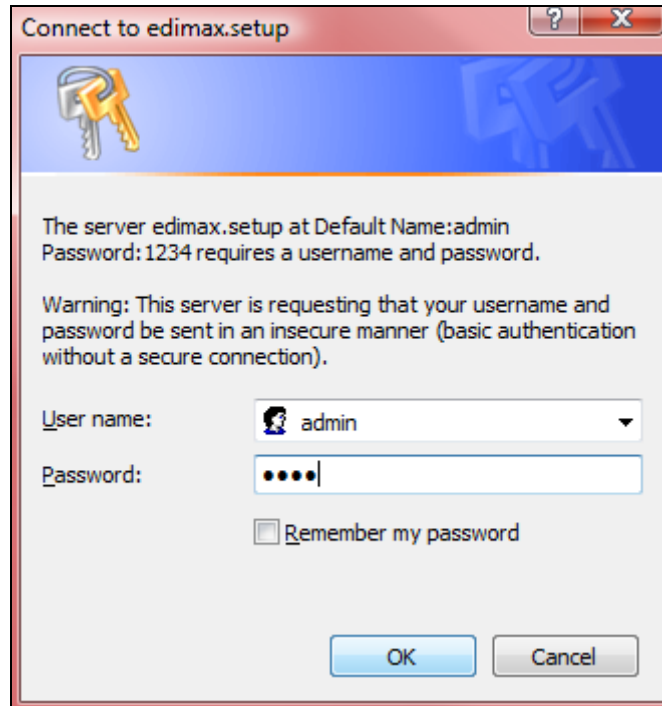

3. You will arrive at the “Status” screen. Use the menu down the left side to navigate.

EDIMAX NETWORKING PEOPLE TOGETHER Wi-Fi Router English

Help

► Status

► Setup Wizard

► Internet

► LAN

► 2.4GHz Wireless

► 5GHz Wireless

► USB

► Firewall

► QoS

► Advanced

► Administration

System Status

System		LAN	
Model	Wireless Router	IP Address	192.168.2.1
Current Time	2015/7/17 11:43:26	Subnet Mask	255.255.255.0
Hardware Version	Rev. A	DHCP Server	Enable
Firmware Version	1.05.0717	MAC Address	82:1f:1f:00:00:c
Check the latest version			

Internet		2.4GHz Wireless	
IP Address Mode	PPPoE Connect	Mode	Access Point
IP Address	118.161.34.36	SSID	edimax_2.4G_00000C
Subnet Mask	255.255.255.255	Channel Number	2
Default Gateway Address	168.95.98.254	Security	WPA2 (AES)
MAC Address	82:1F:1F:00:00:0D	MAC Address	82:1f:1f:00:00:c
DNS 1	168.95.192.1		
DNS 2	168.95.1.1		
DNS 3	168.95.1.1		

5GHz Wireless	
Mode	Access Point
SSID	edimax_5G_00000E
Channel Number	44
Security	WPA2 (AES)
MAC Address	82:1f:1f:00:00:0e

III-2. Save Settings

1. After you configure any settings, click the “Save Settings” button at the bottom of the screen to save your changes.



The device needs to restart in order to bring any changes into effect.

2. Then, click “Click here to restart” in order to restart the device and bring the changes into effect.

Settings have been saved. Please [click here to restart](#) the router and bring the new settings into effect.

3. To make several changes at once, use the “Save Settings” button after each change and then click “click here to restart” after your final change. Only one restart is necessary as long as each change is saved with the “Save Settings” button.



After you click “click here to restart”, all saved changes will come into effect.

III-3. Main Menu

The main menu displays different options depending on your device's operating mode.



For Range Extender mode: WPS please refer to 2.4GHz Wireless & 5GHz Wireless → WPS

Wi-Fi Router

- ▶ Status
- ▶ Setup Wizard
- ▶ Internet
- ▶ LAN
- ▶ 2.4GHz Wireless
- ▶ 5GHz Wireless
- ▶ USB
- ▶ Firewall
- ▶ QoS
- ▶ Advanced
- ▶ Administration

Access Point

- ▶ Status
- ▶ Setup Wizard
- ▶ LAN
- ▶ 2.4GHz Wireless
- ▶ 5GHz Wireless
- ▶ Advanced
- ▶ Administration

Range Extender

- ▶ Status
- ▶ Setup Wizard
- ▶ LAN
- ▶ 2.4GHz Wireless
- ▶ 5GHz Wireless
- ▶ Administration

Wireless Bridge

- ▶ Status
- ▶ Setup Wizard
- ▶ Administration

WISP

- ▶ Status
- ▶ Setup Wizard
- ▶ WISP
- ▶ LAN
- ▶ 2.4GHz Wireless
- ▶ 5GHz Wireless
- ▶ Firewall
- ▶ QoS
- ▶ Advanced
- ▶ Administration

III-3-1. Status



The “Status” page displays basic system information about the device, arranged into categories.



Screenshots displayed are examples. The information shown on your screen will vary depending on your configuration.

The screenshot shows the EDIMAX Wi-Fi Router web interface. The top navigation bar includes the EDIMAX logo, 'Wi-Fi Router', and a language dropdown set to 'English'. A 'Help' button is located in the top right corner. The left sidebar contains a menu with the following items: Status (highlighted), Setup Wizard, Internet, LAN, 2.4GHz Wireless, 5GHz Wireless, USB, Firewall, QoS, Advanced, and Administration.

The main content area displays the 'System Status' page, which is organized into five sections:

- System:** Model: Wireless Router; Current Time: 2015/7/17 11:43:26; Hardware Version: Rev. A; Firmware Version: 1.05.0717. Below this is an orange button labeled 'Check the latest version'.
- LAN:** IP Address: 192.168.2.1; Subnet Mask: 255.255.255.0; DHCP Server: Enable; MAC Address: 82:1f:1f:00:00:0c.
- Internet:** IP Address Mode: PPPoE Connect; IP Address: 118.161.34.36; Subnet Mask: 255.255.255.255; Default Gateway Address: 168.95.98.254; MAC Address: 82:1F:1F:00:00:0D; DNS 1: 168.95.192.1; DNS 2: 168.95.1.1; DNS 3: 168.95.1.1.
- 2.4GHz Wireless:** Mode: Access Point; SSID: edimax_2.4G_00000C; Channel Number: 2; Security: WPA2 (AES); MAC Address: 82:1f:1f:00:00:0c.
- 5GHz Wireless:** Mode: Access Point; SSID: edimax_5G_00000E; Channel Number: 44; Security: WPA2 (AES); MAC Address: 82:1f:1f:00:00:0e.

You can click the orange **Check the latest version** button to open a new screen and automatically upgrade firmware to the latest version. Click **Firmware auto-upgrade** to begin the process.



It is recommended to backup the existing firmware version using the “Save as File” button before upgrading.

III-3-2. Setup Wizard

Setup Wizard You can run the setup wizard again to reconfigure the basic settings of the device, or you can run a wizard to help you switch the device to a different operating mode. Select “Setup Wizard” or “Switch to Router/Access Point/Range Extender/Wireless Bridge/WISP mode” and then click “Run Wizard” to begin.

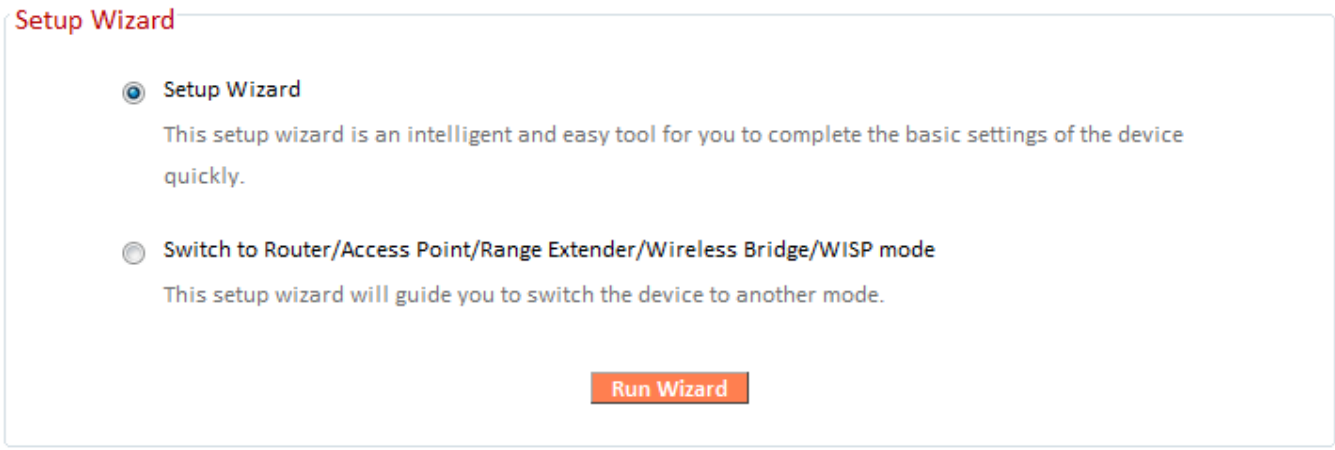

Setup Wizard	This wizard will help you to set up the basic functions and settings of the device. For guidance about using the setup wizard, please refer to II. Installation .
Switch to Router/Access Point/ Range Extender/ Wireless Bridge/ WISP mode	This wizard will help you to switch the device to a different operating mode: Wi-Fi router mode, access point mode, range extender, wireless bridge, or WISP mode (see below).

Switch to Router/Access Point/ Range Extender/ Wireless Bridge/ WISP mode:

1. Follow the on-screen instructions to back up your current settings and then reset the device back to its factory default settings.
2. After the device has reset you will see the screen below. Close your browser and open it again.

Reset to Default

You have successfully reset the device to factory defaults. Please close the browser and open it again. This device will start running the setup wizard for you to switch the mode.

3. Follow the on-screen wizard to setup your device in a different mode. Refer to [II. Installation Step 3](#) onwards for help if needed.



If you don't see the "Get Started" screen, try reconnecting to the edimax.setup SSID and go to <http://edimax.setup> in a web browser.

III-3-3. Internet/WISP

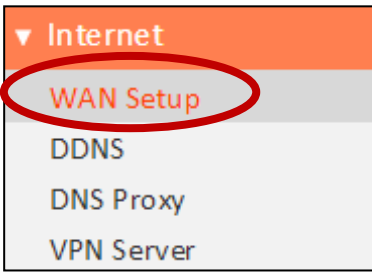

The “Internet” menu provides access to WAN, DDNS, DNS Proxy & VPN server settings. Click on an item from the submenu to view and/or configure the settings.

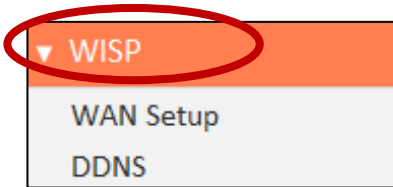

In WISP mode, the screen below will be displayed:

WISP

Enable / Disable Disable Enable

Basic Settings :

 SSID

 Site Survey 2.4G 5G

 Channel Number

Security Setting :

 Encryption

 WPA Unicast Cipher Suite WPA (TKIP) WPA2 (AES)

 Pre-shared Key Format

 Pre-shared Key

Enable / Disable	Enable or disable your WISP connection.
SSID	The name of the WISP network which your BR-6478 AC V2 is connected to. Manually enter an SSID if you wish or use “Site Survey” below.
Site Survey	Select wireless frequency and click “Select Site List” to open a new window and select your WISP network.
Security Setting	Please refer to III-3-5-1. Basic for a

	description of security settings.
--	-----------------------------------

III-3-3-1. WAN Setup

Select a Wide Area Network (WAN) connection mode and configure the settings. If you are unsure about your connection type, contact your ISP.



In WISP mode, only Dynamic IP, Static IP & PPPoE are available for WAN Connection Mode.

WAN Connection Mode

Connection Mode: Dynamic IP ▾

Dynamic IP

Host Name:

Dynamic IP options: Dynamic IP, Static IP, PPPoE, PPTP, L2TP

III-3-3-1-1. Dynamic IP

Select “Dynamic IP”. If your Internet service provider assigns IP address automatically using DHCP (Dynamic Host Configuration Protocol).

Dynamic IP

Host Name:

MAC Address: Clone MAC

DNS Address: Obtain an IP address automatically
 Use the following IP address

DNS1 Address:

DNS2 Address:

DNS3 Address:

MTU: (576<= MTU Value <=1500)

TTL: Disable Enable

Save Settings

Host Name	Enter the host name of your computer.
MAC Address	For some applications, you may need to designate a specific MAC address for the router. Please enter the MAC address here. If you are connecting the router to a computer, press “Clone Mac” to automatically enter your computer’s MAC address.
DNS Address	Select “Obtain an IP address automatically” or “Use the following IP address”. Check with your ISP if you are unsure.
DNS Address 1,2 & 3	Enter the DNS address(es) assigned by your ISP here.
MTU	Enter the maximum transmission unit (MTU) value of your network connection. The default value is 1500.
TTL	Enable/Disable time to live (TTL) function which limits the lifespan of network data to improve performance.

III-3-3-1-2. Static IP

Select “Static IP” if your ISP provides Internet access via a fixed IP address. Your ISP will provide you with such information as IP address, subnet mask, gateway address, and DNS address.

Static IP

Fixed IP IP Address

Subnet Mask

Default Gateway Address

MAC Address

DNS1 Address

DNS2 Address

DNS3 Address

MTU (576<= MTU Value <=1500)

TTL Disable Enable

Fixed IP Address	Input the IP address assigned by your ISP here.
Subnet Mask	Input the subnet mask assigned by your ISP here.
Default Gateway Address	Input the default gateway assigned by your ISP here. Some ISPs may call this “Default Route”.
MAC Address	For some applications, you may need to designate a specific MAC address for the router. Please enter the MAC address here. If you are connecting the router to a computer, press “Clone Mac” to automatically enter your computer’s MAC address.
DNS Address 1, 2 & 3	Enter the DNS address(es) assigned by your ISP here.
DNS Proxy	Enable or disable a DNS proxy server.
DNS Proxy Rules	When DNS proxy is enabled, enter the URL of

(URL)	a DNS proxy server.
TTL	Enable/Disable time to live (TTL) function which limits the lifespan of network data to improve performance.

III-3-3-1-3. PPPoE

Select “PPPoE” if your ISP is providing you Internet access via PPPoE (Point-to-Point Protocol over Ethernet).

PPPoE

User Name: 74900117@wifi.hinet.net

Password: 47835332

MAC Address: 000000000000 **Clone MAC**

DNS Address: Obtain an IP address automatically
 Use the following IP address

DNS1 Address: 0.0.0.0

DNS2 Address: 0.0.0.0

DNS3 Address: 0.0.0.0

TTL: Disable Enable

Service Name:

MTU: 1492 (576<= MTU Value <=1492)

Connection Type: Continuous **Connect** **Disconnect**

Idle Time Out: 10 (1-1000 minutes)

Enable Dual Wan Access :

IGMP Source: ETH PPP

Dynamic IP Static IP

Host Name:

MAC Address: 000000000000 **Clone MAC**

Save Settings

User Name	Enter the user name assigned by your ISP here.
Password	Enter the password assigned by your ISP here.
MAC Address	For some applications, you may need to designate a specific MAC address for the router. Please enter the MAC address here. If you are connecting the router to a computer, press “Clone Mac” to automatically enter

	your computer's MAC address.
DNS Address	Select "Obtain an IP address automatically" or "Use the following IP address". Check with your ISP if you are unsure.
DNS Address 1, 2 & 3	Enter the DNS address(es) assigned by your ISP here.
TTL	Enable or disable TTL.
Service Name	Give this Internet service a name (optional).
MTU	Enter the maximum transmission unit (MTU) value of your network connection. The default value is 1392.
Connection Type	Specify a connection type: <ol style="list-style-type: none"> 1. "Continuous": Connected all the time. 2. "Connect on Demand": Connect when you initiate an Internet connection. 3. "Manual": Connect/disconnect manually using the "Connect" and "Disconnect" buttons.
Idle Time Out	Specify the amount of time the router waits before shutting down an idle connection. Only available when "Connect on Demand" (above) is selected.
Enable Dual-WAN Access	Enable/disable dual WAN access. When you enable dual WAN access, select an IGMP source and enter a "Host Name" and "MAC Address".

III-3-3-1-4. PPTP

Select “PPTP” if your ISP is providing you Internet access via PPTP (Point-to-Point Tunneling Protocol). Then select “Obtain an IP address automatically” or “Use the following IP address” depending on your ISP.

PPTP

Obtain an IP address automatically :

Host Name

MAC Address **Clone MAC**

Use the following IP address :

Static IP Address

Subnet Mask

Default Gateway Address

MAC Address **Clone MAC**

DNS Address Obtain an IP address automatically
 Use the following IP address

DNS1 Address

DNS2 Address

DNS3 Address

DNS Proxy Disable Enable

DNS Proxy Rules (URL)

Enable Dual Wan Access :

IGMP Source ETH PPP

PPTP Settings :

User ID

Password

PPTP Gateway

Connection ID (Optional)

MTU (512<= MTU Value <=1492)

BEZeq-ISRAEL Enable (for use with BEZeq network in Israel only)

Connection Type **Connect** **Disconnect**

Idle Time Out (1-1000 minutes)

Save Settings

Host Name	Enter the host name of your computer here If required.
MAC Address	For some applications, you may need to designate a specific MAC address for the router. Please enter the MAC address here. If you are connecting the router to a computer, press “Clone Mac” to automatically enter your computer’s MAC address.
Static IP Address	Input the IP address assigned by your ISP here.
Subnet Mask	Input the subnet mask assigned by your ISP here.
Default Gateway Address	Input the default gateway assigned by your ISP here. Some ISPs may call this “Default Route”.
MAC Address	If your ISP filters access by MAC addresses, enter your computer’s MAC address here. Click “Clone MAC” to automatically enter your computer’s MAC address.
DNS Address	Select “Obtain an IP address automatically” or “Use the following IP address”. Check with your ISP if you are unsure.
DNS Address 1,2 & 3	Enter the DNS address(es) assigned by your ISP here.
DNS Proxy	Enable or disable a DNS proxy server.
DNS Proxy Rules (URL)	When DNS proxy is enabled, enter the URL of a DNS proxy server.
Enable Dual-WAN Access	Enable/disable dual WAN access. When you enable dual WAN access, select an IGMP source.
User ID	Input the user name assigned by your ISP here.
Password	Input the password assigned by your ISP here.
PPTP Gateway	Input the PPTP gateway assigned by your ISP here.
Connection ID	Specify a reference name/ID for the connection.
MTU	Enter the maximum transmission unit (MTU) value of your network connection. The default value is 1392.
BEZEQ-ISRAEL	Check the “Enable” box if you are using BEZEQ network services (Israel users only).
Connection Type	Specify a connection type: <ol style="list-style-type: none"> 1. “Continuous”: Connected all the time. 2. “Connect on Demand”: Connect when you initiate an Internet connection. 3. “Manual”: Connect/disconnect manually using

	the “Connect” and “Disconnect” buttons.
Idle Time Out	Specify the amount of time the router waits before shutting down an idle connection. Only available when “Connect on Demand” (above) is selected.

III-3-3-1-5. L2TP

Select “L2TP” if your ISP is providing you Internet access via L2TP (Layer 2 Tunneling Protocol).

PPTP

Obtain an IP address automatically :

Host Name
 MAC Address **Clone MAC**

Use the following IP address :

Static IP Address
 Subnet Mask
 Default Gateway Address
 MAC Address **Clone MAC**
 DNS Address Obtain an IP address automatically
 Use the following IP address
 DNS1 Address
 DNS2 Address
 DNS3 Address

Enable Dual Wan Access :

IGMP Source ETH PPP

L2TP Settings :

User ID
 Password
 L2TP Gateway
 MTU (512<= MTU Value <=1492)
 Connection Type **Connect** **Disconnect**
 Idle Time Out (1-1000 minutes)

Save Settings

Host Name	Enter the host name of your computer here If required.
------------------	--

MAC Address	For some applications, you may need to designate a specific MAC address for the router. Please enter the MAC address here. If you are connecting the router to a computer, press “Clone Mac” to automatically enter your computer’s MAC address.
Static IP Address	Input the IP address assigned by your ISP here.
Subnet Mask	Input the subnet mask assigned by your ISP here.
Default Gateway Address	Input the default gateway assigned by your ISP here. Some ISPs may call this “Default Route”.
MAC Address	If your ISP filters access by MAC addresses, enter your computer’s MAC address here. Click “Clone MAC” to automatically enter your computer’s MAC address.
DNS Address	Select “Obtain an IP address automatically” or “Use the following IP address”. Check with your ISP if you are unsure.
DNS Address 1,2 & 3	Enter the DNS address(es) assigned by your ISP here.
Enable Dual-WAN Access	Enable/disable dual WAN access. When you enable dual WAN access, select an IGMP source and enter a “Host Name” and “MAC Address”.
User ID	Input the user name assigned by your ISP here.
Password	Input the password assigned by your ISP here.
L2TP Gateway	Input the L2TP gateway assigned by your ISP here.
Connection ID	Specify a reference name/ID for the connection.
MTU	Enter the maximum transmission unit (MTU) value of your network connection. The default value is 1392.
Connection Type	Specify a connection type: <ol style="list-style-type: none"> 1. “Continuous”: Connected all the time. 2. “Connect on Demand”: Connect when you initiate an Internet connection. 3. “Manual”: Connect/disconnect manually using the “Connect” and “Disconnect” buttons.
Idle Time Out	Specify the amount of time the router waits before shutting down an idle connection. Only available when “Connect on Demand” (above) is selected.

III-3-3-2. DDNS

Dynamic DNS (DDNS) is a service which provides a hostname-to-IP service for dynamic IP users. The changing nature of dynamic IPs means that it can be difficult to access a service provided by a dynamic IP user; a DDNS service though can map such dynamic IP addresses to a fixed hostname, for easier access. The router supports several DDNS service providers, for more details and to register for a DDNS account please visit the DDNS providers website(s), examples of which are listed below.

DDNS

Enable / Disable Enable Disable

Provider

Domain Name

Account / E-mail

Password / Key

Enable/Disable	Enable or disable DDNS
Provider	Select DDNS service provider.
Domain Name	Enter the domain name provided by the DDNS provider.
Account/Email	Please enter the DDNS registration account/email.
Password/Key	Enter the DDNS service password/key.

The following DDNS services are supported:

- 3322** <http://www.3322.org>
- DHS** <http://www.dhs.org>
- DynDNS** <http://www.dyndns.org>
- ODS** <http://ods.org>
- TZO** <http://www.tzo.com>
- GnuDIP** <http://gnudip2.sourceforge.net>
- DyNS** <http://www.dyns.cx/>
- ZoneEdit** <http://www.zoneedit.com>

DHIS	<i>http://www.dhis.org/</i>
CyberGate	<i>http://cybergate.planex.co.jp/ddns/</i>
NS2GO	<i>http://www.ns2go.com/</i>
NO-IP	<i>http://www.noip.com/</i>

III-3-3-3. DNS Proxy

DNS Proxy is a DNS service which re-routes traffic to a proxy server in a different geographical location/region.

DNS Proxy

DNS Proxy Disable Enable

DNS Proxy Rules (URL)

Select Your Rules Original rules User define rules

User define rules : (Only 50 sets of Domain Name are allowed.)

NO.	Domain Name	Proxy Server IP	
No data available in table			

Original rules :

NO.	Domain Name	Proxy Server IP	
No data available in table			

DNS Proxy	Enable or disable a DNS proxy server.
DNS Proxy Rules (URL)	When DNS proxy is enabled, enter the URL of a DNS proxy server.
Select Your Rules	Enter the domain name provided by the DDNS provider.

III-3-3-4. VPN Server

A VPN is a virtual private network which you can connect to remotely. VPNs are secure and encrypted. Your router has a built-in VPN server which you can configure and access on your network devices, including smartphones, tablets and computers.

OpenVPN Server

Enabled VPN Server :  **1**

Server Information :

EDIMAX DDNS	023se0004f.router.myedimax.com
VPN Subnet/Netmask	10.8.0.0/255.255.255.0
Protocol	UDP
Server Port	443

Client Configuration Files :

Send All Traffic Over VPN Server	Export	2	more...
Send "Only" Home-Network Traffic Over VPN Server	Export		more...

OpenVPN Client Setting

[Windows](#)

[Mac OS](#)

[iOS](#)

[Android](#)

4

OpenVPN Client Account Control

Status	Client Name	Password	
	<input type="text"/>	<input type="text"/>	3 Add
Disconnect	admin	--	Change

1. Enable VPN server.
2. Export your VPN server configuration file. You can open this file on your network device (smartphone, tablet, computer) using VPN software/app to automatically connect to your VPN on your device.



You can choose which kind of configuration file to export, depending on your requirement. "Send All Traffic Over VPN"

Server” will configure your network device to use the VPN for all Internet traffic. “Send Only Home Network Traffic over VPN Server” will configure your network device to access the Internet as usual but use the VPN to access your home (router) network. The 2nd option is ideal if you only wish to use the VPN for remote access to your home network. The 1st option will encrypt all Internet traffic through the VPN.

- 3.** Setup a login account for your VPN. This is required to access your VPN on your network device.
- 4.** Send the exported configuration file to your network device (e.g. via email, cloud or USB). Open the file using VPN software or apps which are widely available online, and enter your login details to connect to your VPN.



You can access further help to connect your network device to your VPN by selecting your operating system under “OpenVPN Client Settings”.

III-3-4. LAN



You can configure your Local Area Network (LAN) on this page. You can enable the router to dynamically allocate IP addresses to your LAN clients, and you can modify the IP address of the device. The device’s default IP address is 192.168.2.1.



You can access the browser based configuration interface using the device’s IP address instead of using the URL <http://edimax.setup>.

LAN IP

IP Address	<input type="text" value="192.168.2.1"/>
Subnet Mask	<input type="text" value="255.255.255.0"/>
802.1d Spanning Tree	<input type="text" value="Disable"/> ▼

IP Address	Specify the IP address here. This IP address will be assigned to the BR-6478 AC V2 and will replace the default IP address.
Subnet Mask	Specify a subnet mask. The default value is 255.255.255.0
802.1d Spanning Tree	Select “Enable” or “Disable” to enable/disable 802.1d Spanning Tree. This creates a tree of connected layer-2 bridges (typically Ethernet switches) within a mesh network, and disables those links that are not part of the tree, leaving a single active path between any two network nodes.

Your device’s DHCP server automatically assigns IP addresses to computers on its network, between a defined range of numbers.

DHCP Server

DHCP Server

Lease Time

Start IP

End IP

DHCP Server	Enable or disable the DHCP server.
Lease Time	Select a lease time for the DHCP leases here. The DHCP client will obtain a new IP address after the period expires.
Start IP	Enter the start IP address for the DHCP server's IP address leases.
End IP	Enter the end IP address for the DHCP server's IP address leases.

Your device's DHCP server can be configured to assign static (fixed) IP addresses to specified network devices, identified by their unique MAC address.

Static DHCP Lease Table

Enable Static DHCP Leases

MAC Address IP Address

Only 32 sets of addresses are allowed.

NO.	MAC Address	IP Address	Select
1	aa:bb:cc:dd:ee:ff	192.168.2.110	<input type="checkbox"/>

Enable Static DHCP Leases	Enable/disable static DHCP leases. This must be enabled in order to assign any network device a static IP address.
MAC Address	Enter the specified network device's MAC address here.
IP Address	Assign a fixed IP address for the specified network device here.
Add	Add the information to the "Static DHCP

	Leases Table”.
Clear	Clear the MAC address and IP address fields.
Delete Selected / Delete All	Delete selected or all entries from the table.



The LAN IP page will be displayed as below when your device is set to access point mode & extender mode. You can set the BR-6478 AC V2 to obtain an IP address automatically or you can specify an IP address.

LAN IP

Obtain an IP address automatically
 Use the following IP address

IP Address
 Subnet Mask
 Default Gateway Address
 DNS Address

III-3-5. 2.4GHz Wireless & 5GHz Wireless

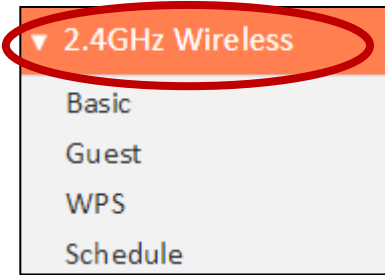

The “2.4GHz Wireless” & “5GHz Wireless” menu allows you to configure SSID and security settings for your Wi-Fi network along with a guest Wi-Fi network. WPS, access control and scheduling functions can also be managed from here.



Access Point Mode:

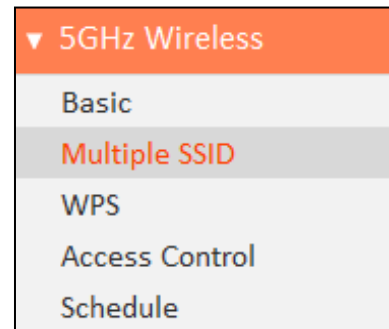
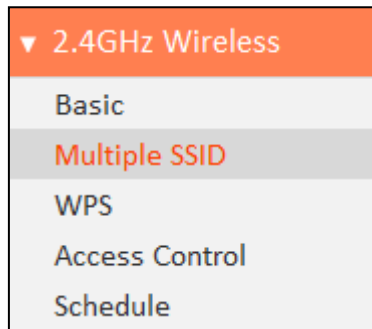

In Access Point mode, the “Guest” feature in the menu is replaced by “Multiple SSID”.

III-3-5-1. Basic

The “Basic” screen displays settings for your primary 2.4GHz or 5GHz Wi-Fi network.

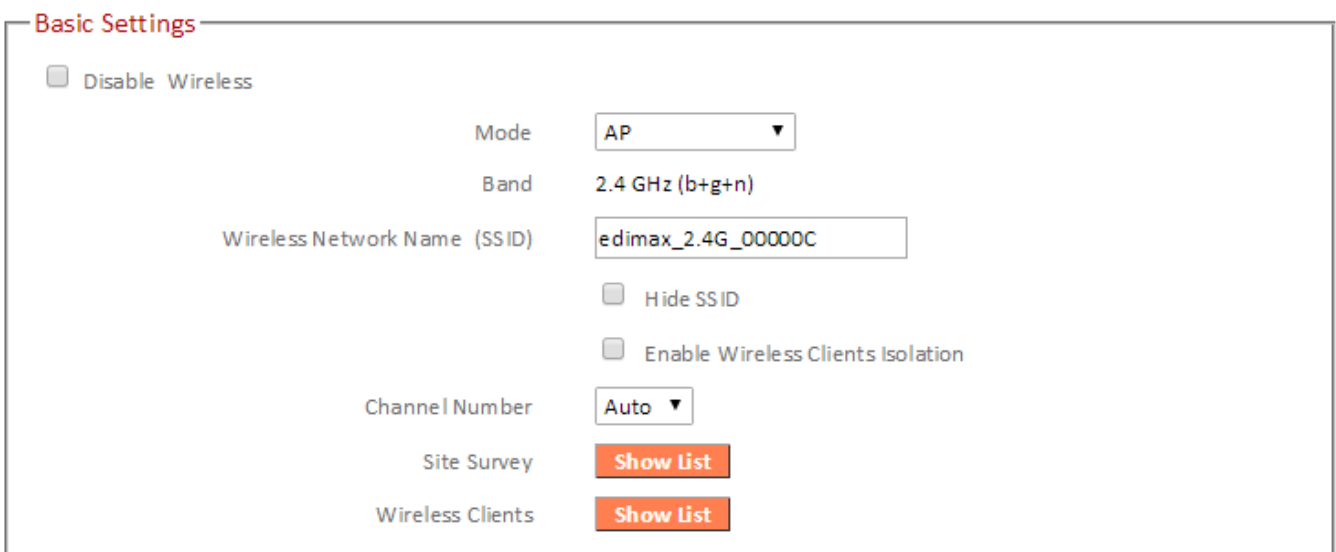

Disable Wireless

Check the box to disable the wireless function of your device.

Mode	Keep the default “AP” value for the device to act as a standard wireless access point, or select “AP Bridge-WDS” for the device to function in WDS mode (see below).
Band	Displays the wireless standard used for the BR-6478 AC V2’s “2.4GHz (B+G+N)” means that 802.11b, 802.11g, and 802.11n wireless clients can connect to the BR-6478 AC V2.
Wireless Network Name (SSID)	This is the name of your Wi-Fi network for identification, also sometimes referred to as “SSID”. The SSID can consist of any combination of up to 32 alphanumeric characters.
Hide SSID	Enable or disable hide SSID. When disabled, the SSID will be visible to clients as an available Wi-Fi network. When enabled, the SSID will not be visible as an available Wi-Fi network to clients – clients must manually enter the SSID in order to connect. A hidden (disabled) SSID is typically more secure than a visible (enabled) SSID.
Enable Wireless Clients Isolation	Check the box to enable wireless clients isolation. This prevents wireless clients connected to the BR-6478 AC V2 from communicating with each other and improves security. Typically, this function is useful for corporate environments or public hot spots and can prevent brute force attacks on clients’ usernames and passwords.
Channel Number	Select a wireless radio channel or use the default “Auto” setting from the drop-down menu.
Site Survey	Click “Select Site List” to display a new window showing information about the surrounding wireless environment. This information is useful to select an effective wireless channel number.
Wireless Clients	Click “Show List” to display a new window showing information about wireless clients. Please disable any pop-up blockers if you have difficulty using this function.

AP Bridge-WDS:

Mode	AP Bridge-WDS
Band	AP AP Bridge-WDS

Wireless Distribution System (WDS) can bridge/repeat access points together in an extended network. WDS settings can be configured as shown below.



When using WDS, configure the IP address of each access point to be in the same subnet and ensure there is only one active DHCP server among connected access points, preferably on the WAN side.

WDS must be configured on each access point, using correct MAC addresses. All access points should use the same wireless channel.

MAC Address 1	000000000000
MAC Address 2	000000000000
MAC Address 3	000000000000
MAC Address 4	000000000000
Set Security	Set Security

MAC Address 1 - 4	Enter the correct MAC address for other access points in WDS mode.
Set Security	Click “Set Security” to open a new window and enter the security settings for WDS (shown below). Click “Save” when finished.



Please ensure you setup and save wireless security settings before you click “Set Security” to set WDS security settings.

AP Bridge-WDS Security Setting

Encryption

WPA Unicast Cipher Suite WPA2 (AES)

Pre-shared Key Format

Pre-shared Key

Save

Close

Wireless Security:

Wireless Security

Encryption: WEP

Key Length: 64-bit

Key Format: Hex (10 characters)

Encryption Key: ●●●●●●●● Hide

Enable 802.1x Authentication

Select an encryption type from the drop-down menu:



“WPA Pre-shared Key” is the recommended and most secure encryption type.



In WISP mode, WPA RADIUS is unavailable for the wireless band that is used to connect to WISP’s AP.

Wireless Security

Encryption: Disable

Enable 802.1x Authentication

Drop-down menu options: Disable, WEP, WPA Pre-shared Key, WPA RADIUS

III-3-5-1-1. Disable

Encryption is disabled and no password/key is required to connect to the BR-6478 AC V2.



Disabling wireless encryption is not recommended. When disabled, anybody within range can connect to your device's SSID.

Enable 802.1x Authentication	Check the box to enable the 802.1x authentication. A RADIUS server is required to perform 802.1x authentication: enter the RADIUS server's information in the relevant fields (below).
-------------------------------------	--

Enable 802.1x Authentication

RADIUS Server IP address

RADIUS Server Port

RADIUS Server Password

III-3-5-1-2. WEP

WEP (Wired Equivalent Privacy) is a basic encryption type. For a higher level of security consider using WPA encryption.

Wireless Security

Encryption:

Key Length:

Key Format:

Encryption Key: Hide

Enable 802.1x Authentication

Key Length	Select 64-bit or 128-bit. 128-bit is more secure than 64-bit.
Key Format	Choose from “ASCII” (any alphanumerical character 0-9, a-z and A-Z) or “Hex” (any characters from 0-9, a-f and A-F).
Encryption Key	Enter your encryption key/password according to the format you selected above. A complex, hard-to-guess key is recommended. Check the “Hide” box to hide your password from being displayed on-screen.
Enable 802.1x Authentication	Check the box to enable the 802.1x authentication. A RADIUS server is required to perform 802.1x authentication: enter the RADIUS server’s information in the relevant fields (below).

Enable 802.1x Authentication

RADIUS Server IP address:

RADIUS Server Port:

RADIUS Server Password:

III-3-5-1-3. WPA Pre-Shared Key

WPA pre-shared key is the recommended and most secure encryption type.

Wireless Security

Encryption: WPA Pre-shared Key

WPA Unicast Cipher Suite: WPA (TKIP) WPA2 (AES) WPA2 Mixed

Pre-shared Key Format: Passphrase

Pre-shared Key: Hide

WPA Unicast Cipher Suite	Select from WPA (TKIP), WPA2 (AES) or WPA2 Mixed. WPA2 (AES) is safer than WPA (TKIP), but not supported by all wireless clients. Please make sure your wireless client supports your selection. WPA2 (AES) is recommended followed by WPA2 Mixed if your client does not support WPA2 (AES).
Pre-shared Key Format	Choose from “Passphrase” (8-63 alphanumeric characters) or “Hex” (up to 64 characters from 0-9, a-f and A-F).
Pre-shared Key	Please enter a key according to the format you selected above. A complex, hard-to-guess key is recommended. Check the “Hide” box to hide your password from being displayed on-screen.

III-3-5-1-4. WPA Radius

WPA RADIUS is a combination of WPA encryption and RADIUS user authentication. If you have a RADIUS authentication server, you can authenticate the identity of every wireless client against a user database.

Wireless Security

Encryption:

WPA Unicast Cipher Suite: WPA (TKIP) WPA2 (AES) WPA2 Mixed

RADIUS Server IP address:

RADIUS Server Port:

RADIUS Server Password:

WPA Unicast Cipher Suite	Select from WPA (TKIP), WPA2 (AES) or WPA2 Mixed. WPA2 (AES) is safer than WPA (TKIP), but not supported by all wireless clients. Please make sure your wireless client supports your selection. WPA2 (AES) is recommended followed by WPA2 Mixed if your client does not support WPA2 (AES).
RADIUS Server IP address	Input the IP address of the RADIUS authentication server here.
RADIUS Server Port	Input the port number of the RADIUS authentication server here. The default value is 1812.
RADIUS Server Password	Input the password of the RADIUS authentication server here.

III-3-5-2. Guest/Multiple SSID

You can setup an additional “Guest” Wi-Fi network so guest users can enjoy Wi-Fi connectivity without accessing your primary network. The “Guest” screen displays settings for your guest Wi-Fi network.



The guest network is separate from your primary network. The settings for your primary network can be found in the “Basic” menu.



In access point mode, the “Guest” feature in the menu is replaced by “Multiple SSID”. The BR-6478 AC V2 supports up to four additional SSIDs for each wireless band in access point mode.

Basic Settings

Enable Guest SSID

Guest Wireless Name

Hide SSID

Enable Wireless Clients Isolation

Band 2.4 GHz (b+g+n)

Channel Number 1 (Same as main SSID)

Wireless Security

Encryption

Enable Guest SSID	Check/uncheck the box to enable/disable the guest Wi-Fi network.
Wireless Guest Name	Enter a reference/ID name for your guest wireless network.
Hide SSID	Enable or disable hide SSID. When disabled, the SSID will be visible to clients as an available Wi-Fi network. When enabled, the SSID will not be visible as an available Wi-Fi network to clients – clients must manually enter the SSID in order to connect. A hidden (disabled) SSID is typically more secure than a visible (enabled) SSID.
Enable Wireless	Check the box to enable wireless clients

Clients Isolation	isolation. This prevents wireless clients connected to the BR-6478 AC V2 from communicating with each other and improves security. Typically, this function is useful for corporate environments or public hot spots and can prevent brute force attacks on clients' usernames and passwords.
Band	Displays the wireless standard used for the BR-6478 AC V2's frequency band: 2.4GHz (B+G+N): Allows 802.11b, 802.11g, and 802.11n wireless clients to connect to the BR-6478 AC V2.
Channel Number	Channel number for the guest network is the same as the main SSID and cannot be adjusted independently.

Encryption	Please refer to III-3-5-1. Basic: Wireless Security for details about security settings.
-------------------	--



WPA RADIUS encryption type is not available for the guest network.

MULTIPLE SSID:

The BR-6478 AC V2 supports up to four additional SSIDs for each wireless band in access point mode. Once configured, these SSIDs are displayed in the "Multiple SSID Status" table as shown below. Use the "Multiple SSID Basic Settings" box to configure additional SSIDs.

NO.	Status	SSID	VLAN ID	Encryption	MAC Address
1	Enabled	edimax.1	0	Disable	82:1F:1F:00:00:0C
2	Enabled	edimax.2	0	Disable	82:1F:1F:01:00:0C
3	Enabled	VLAN	1	Disable	82:1F:1F:02:00:0C
4	Disable	edimax.4	0	Disable	82:1F:1F:03:00:0C

Multiple SSID Basic Settings

Multiple SSID (MAC Address : 82:1F:1F:00:00:0C)

Enable Multiple SSID

Wireless Network Name (SSID)

Enable Wireless Clients Isolation

Broadcast SSID

Band 2.4 GHz (b+g+n)

Channel Number Auto (Same as main SSID)

VLAN ID (Untagged:0, Tagged:1~4094)

Multiple SSID	Use the drop down menu to select which SSID (numbered 1 – 4) to configure.
Enable Multiple SSID	Check/uncheck this box to enable/disable the specified SSID. Must be checked for the SSID to function.
Wireless Network Name (SSID)	Enter a reference/ID name to separate your wireless network.
Enable Wireless Clients Isolation	Check the box to enable wireless clients isolation. This prevents wireless clients connected to the BR-6478 AC V2 from communicating with each other and improves security. Typically, this function is useful for corporate environments or public hot spots and can prevent brute force attacks on clients' usernames and passwords.
Band	Displays the wireless standard used for the BR-6478 AC V2's frequency band: 2.4GHz (B+G+N): Allows 802.11b, 802.11g, and 802.11n wireless clients to connect to the BR-6478 AC V2.
Channel Number	Channel number for the guest network is the same as the main SSID and cannot be adjusted independently.
VLAN ID	Set a VLAN ID for the specified SSID (see below).



A VLAN is a local area network which maps workstations virtually instead of physically and allows you to group together or isolate users from each other. VLAN IDs 0 – 4094 are supported.

Set wireless security for the specified SSID – security settings are described in **III-3-5-1. Basic.**

Multiple SSID Security

Enable 802.1x Authentication

Encryption

- Disable
- Disable
- WEP
- WPA Pre-shared Key
- WPA RADIUS

III-3-5-3. WPS

Wi-Fi Protected Setup is a simple way to establish connections between WPS compatible devices. WPS can be activated on compatible devices by pushing a WPS button on the device or from within the device’s firmware/configuration interface. When WPS is activated in the correct manner and at the correct time for two compatible devices, they will automatically connect. PIN code WPS includes the use of a PIN code between the two devices for verification.

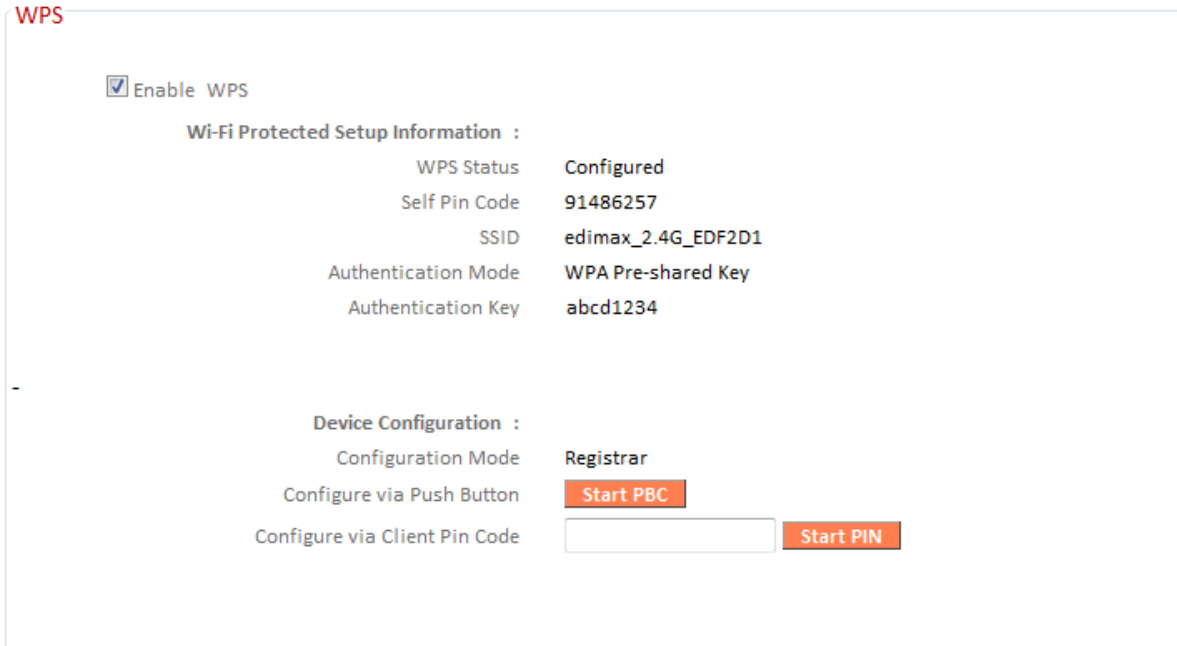

Enable WPS	Check/uncheck this box to enable/disable WPS.
WPS Status	Displays “Configured” or “unConfigured” depending on whether WPS and SSID/security settings for the device have been configured or not, either manually or using the WPS button.
Self PIN Code	Displays the WPS PIN code of the device.
SSID	Displays the SSID of the device.
Authentication Mode	Displays the wireless security authentication mode of the device.
Authentication Key	Displays the wireless security authentication key.
Configuration Mode	The configuration mode of the device’s WPS setting is displayed here. “Registrar” means the device acts as an access point for a wireless client to connect to and the wireless client(s)

	will follow the device's wireless settings.
Configure via Push Button	Click "Start PBC" (Push-Button Configuration) to activate WPS on the access point. WPS will be active for 2 minutes.
Configure via Client PIN Code	Enter the wireless client's PIN code here and click "Start PIN" to activate PIN code WPS. Refer to your wireless client's documentation if you are unsure of its PIN code.

III-3-5-4. Access Control



Access Control is a security feature that can help to prevent unauthorized users from connecting to your wireless router.

This function allows you to define a list of network devices permitted to connect to the BR-6478 AC V2. Devices are each identified by their unique MAC address. If a device which is not on the list of permitted MAC addresses attempts to connect to the BR-6478 AC V2, it will be denied.

To enable this function, check the box labeled "Enable Wireless Access Control".

Access Control

Enable Wireless Access Control

Client PC

----Select----

>>

MAC Address

Comment

Add

MAC Address	Device Name	IP Address	Comment	Select
aa:bb:cc:dd:ee:ff	-	-	Home PC	<input type="checkbox"/>

Delete Selected

Delete All

Save Settings

Settings have been saved. Please [click here to restart](#) the router and bring the new settings into effect.

MAC address	<p>Select a PC name from the drop-down list and click “>>” to add enter it into the blank field to the right.</p> <p>Click “Refresh’ in the drop-down menu to refresh the list of available MAC addresses. If the address you wish to add is not listed, enter it manually.</p> <p>Enter a MAC address of computer or network device manually without dashes or colons e.g. for MAC address ‘aa-bb-cc-dd-ee-ff’ enter ‘aabbccddeeff’.</p>
Comment	Enter a comment for reference/identification consisting of up to 16 alphanumerical characters.
Add	Click “Add” to add the MAC address to the MAC address filtering table.

MAC address entries will be listed in the table as shown below. Select an entry using the “Select” checkbox.

MAC Address	Device Name	IP Address	Comment	Select
aa:bb:cc:dd:ee:ff	-	-	Home PC	<input type="checkbox"/>

Delete Selected
Delete All

Delete Selected/ Delete All	Delete selected or all entries from the table.
--	--

III-3-5-5. Schedule

 **When Cross-Band is enabled in extender mode, wireless scheduling is reversed according to frequency. Your 2.4GHz schedule will apply to your extender's 5GHz network and vice-versa.**

The schedule feature allows you to automate the wireless radio to switch off at specified times. Multiple schedules can be configured. Check/uncheck the box "Enable Wireless Off Schedule" to enable/disable the wireless off scheduling function.

 **The BR-6478 AC V2 must have time & date settings initially set to use scheduling.**

Wireless Schedule

Enable Wireless Off Schedule

Every Day

Start Time

End Time

Start Time	End Time	Select
Sunday - 23:30	Monday - 07:30	<input type="checkbox"/>
Monday - 23:30	Tuesday - 07:30	<input type="checkbox"/>
Tuesday - 23:30	Wednesday - 07:30	<input type="checkbox"/>
Wednesday - 23:30	Thursday - 07:30	<input type="checkbox"/>
Thursday - 23:30	Friday - 07:30	<input type="checkbox"/>
Friday - 23:30	Saturday - 07:30	<input type="checkbox"/>
Saturday - 23:30	Sunday - 07:30	<input type="checkbox"/>

Settings have been saved. Please [click here to restart](#) the device and bring the new settings into effect.



Wireless scheduling can save energy and increase the security of your network.

- 1.** Use the dropdown to select which day(s) to include in the schedule. Check “Every Day” as a shortcut for an every day schedule.
- 2.** Specify a start and end time (hour and minute) for the wireless off schedule using the drop-down menu.

Add	Add the schedule to the table of active schedules.
------------	--

Delete Selected/ Delete All	Delete selected or all entries from the table of active schedules.
--	--

III-3-6. USB

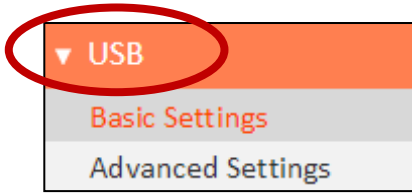

Connect your USB storage to the USB port on the rear of the BR-6478AC V2. USB sharing is enabled by default so devices on your network can access the USB storage drive using appropriate tools for your OS (e.g. Windows File

Explorer → Network).



USB drives should be pre-formatted to supported FAT32 or NTFS file systems before use with the USB port. USB hubs are not supported.

III-3-6-1. Basic Settings

Configure basic USB settings: you can use the USB port for USB storage or for printer sharing. For USB storage you can enable Network Neighborhood access for Windows, and FTP access.

USB Sharing

Enable USB Sharing

USB Storage Print Server

USB Storage

NO	Device Name	Total Space	Free Space	Select
	No Device			

USB Storage Sharing

Enable Network Neighborhood

Network Name : MyStorage
Workgroup : Workgroup
Access Link : \\192.168.2.1\share

FTP Server

FTP : ftp://192.168.2.1 : port

FTP(Internet) : ftp://118.161.34.36 : port

Note: To access FTP server from Internet (remotely) use the address ftp://public IP:port. If the device is restarted, check the public IP address again.

Print Server

- Step1 : Connect your printer to the router with a USB cable.
- Step2 : Install printer drivers on your computer.
- Step3 : Install Edimax USB Device Server Utility on your computer from [here](#) or included on the CD.

Enable USB Sharing	Enable or disable USB Sharing. This must be enabled to use USB storage or printer sharing. Select USB storage or printer sharing.
Enable Network Neighborhood	Enable Network Neighborhood access for Windows if you can't find your USB storage on a Windows device when connected to the network.
FTP Server	Enable FTP access to the USB storage. Modify the port number if required.
FTP Server (Internet)	Enable remote (Internet) FTP access to the USB storage. Modify the port number if required.

III-3-6-2. Advanced Settings

You can configure advanced USB storage settings for access management (folder access settings) and Network Neighborhood.

Network Neighborhood

Network Name :

Workgroup :

Access Management

Share All

Required Authentication

Current Share Folder Table

NO	USB Device	Share Name	Shared Folder	User Name	Password	Permission	Select
No data available in table							

Network Name	Edit the name of the USB storage in the network.
Workgroup	Edit the name of the Network Neighborhood workgroup for your USB storage.

Share All	Select to share all folders and content on your USB storage.
Require Authentication	Select to use password authentication to access USB storage for all folders or only specified folders. Click “Add” to setup authentication.

Add Network Folder

USB Device

File System

Share Name

Folder Name All Folders
 Select Folders

User Name (4~20 characters)

Password (4~20 characters)

Access Limit

USB Device	Displays the name of your attached USB storage.
File System	Displays the file system configured on your USB storage. FAT32 & NTFS are supported.
Share Name	Set a reference name for this sharing configuration.
Folder Name	Specify whether to share all folders or only selected folders. Browse to choose a specific folder to share.
User Name	Select a username.
Password	Select a password.
Access Limit	Select access limit for this USB storage.

III-3-7. Firewall

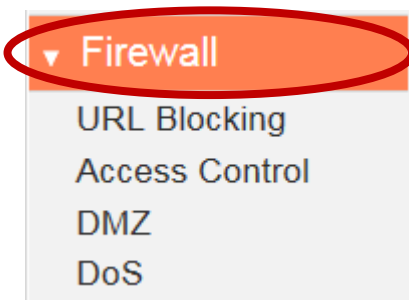

The “Firewall” menu provides access to URL blocking, access control, DMZ and DoS functions to improve the security of your wireless network.



SPI firewall	Enable or disable the Stateful Packet Inspection (SPI) firewall.
---------------------	--

III-3-7-2. Access Control



Access Control (MAC filtering) can also be configured from [III-3-5-4. Access Control](#).

Access Control is a security feature that can help to prevent unauthorized users from connecting to your wireless router.

This function allows you to define a list of network devices permitted or denied to connect to the BR-6478 AC V2. Devices are each identified by their unique MAC address or IP address. Specific services can also be allowed/denied for IP addresses.

Check/uncheck the “Enable MAC Filtering” and/or “Enable IP Filtering” box to enable/disable MAC filtering and/or IP filtering.

Access Control

Enable MAC Filtering : Deny Allow

Client PC MAC Address

Computer Name



---- Select----

Comment

Add

MAC Filtering Table :

NO	Computer Name	Client PC MAC Address	Comment	Select
1	BLOOMHOUSEWIN8	80:1f:02:9c:8f:ff		<input type="checkbox"/>

Delete Selected

Delete All

Enable IP Filtering Table : Deny Allow

IP Filtering Table :

NO	Client PC Description	Client PC IP Address	Client Service	Protocol	Port Range	Select
1	Home	192.168.2.115	TCP, UDP			<input type="checkbox"/>

Add PC

Delete Selected

Delete All

Save Settings

Settings have been saved. Please [click here to restart](#) the router and bring the new settings into effect.

MAC Filtering:

Enable MAC Filtering	Check the box to enable MAC filtering and select whether to “Deny” or “Allow” access for specified MAC address.
Client PC MAC Address	Enter a MAC address of computer or network device manually without dashes or colons e.g. for MAC address ‘aa-bb-cc-dd-ee-ff’ enter ‘aabbccddeeff’.
Computer Name	Select a computer name from the drop-down list and click “<<” to add its MAC address into the “Client PC Mac Address” field. Click “Refresh’ in the drop-down menu to refresh the list of available MAC addresses. If the address you wish to add is not listed, enter it manually.
Comment	Enter a comment for reference/identification consisting of up to 16 alphanumerical characters.
Add	Click “Add” to add the MAC address to the MAC address filtering table.

MAC address entries will be listed in the table. Select an entry using the “Select” checkbox.

MAC Filtering Table :

NO	Computer Name	Client PC MAC Address	Comment	Select
1	BLOOMHOUSEWIN8	80:1f:02:9c:8f:ff		<input type="checkbox"/>

Delete Selected

Delete All

Delete Selected / Delete All	Delete selected or all entries from the table.
-------------------------------------	--

IP Filtering:

Enable IP Filtering	Check the box to enable IP filtering and select whether to “Deny” or “Allow” access for specified IP address.
Add PC	Opens a new window to add a new IP to the list, to deny or allow access/services according to above.

Access Control Add PC

This page allows users to define service limitations of client PCs, including IP address and service type.

Access Control Add PC :

Client PC Description
Client PC IP address -

Client PC Service :

Service Name	Detail Description	Select
WWW	HTTP, TCP Port 80, 3128, 8000, 8080, 8081	<input checked="" type="checkbox"/>
E-mail Sending	SMTP, TCP Port 25	<input checked="" type="checkbox"/>
News Forums	NNTP, TCP Port 119	<input checked="" type="checkbox"/>
E-mail Receiving	POP3, TCP Port 110	<input checked="" type="checkbox"/>
Secure HTTP	HTTPS, TCP Port 443	<input checked="" type="checkbox"/>
File Transfer	FTP, TCP Port 21, 20	<input checked="" type="checkbox"/>
MSN Messenger	TCP Port 1863	<input type="checkbox"/>
Telnet Service	TCP Port 23	<input type="checkbox"/>
AIM	AOL Instant Messenger, TCP Port 5190	<input type="checkbox"/>
NetMeeting	H.323, TCP Port 389,522,1503,1720,1731	<input type="checkbox"/>
DNS	UDP Port 53	<input type="checkbox"/>
SNMP	UDP Port 161, 162	<input type="checkbox"/>
VPN-PPTP	TCP Port 1723	<input type="checkbox"/>
VPN-L2TP	UDP Port 1701	<input type="checkbox"/>
TCP	All TCP Port	<input type="checkbox"/>
UDP	All UDP Port	<input type="checkbox"/>

User Define Service :

Protocol
Port Range

Client PC Description	Enter a description for reference/identification of up to 16 alphanumeric characters.
Client PC IP address	Enter a starting IP address in the left field and the end IP address in the right field to define a range of IP addresses; or enter an IP address in the left field only to define a single IP address.
Service Name	Various services are listed here with a short description. Check/uncheck the box for each service you wish to select.
Protocol	Select protocol "TCP" or "UDP" or "Both" for a service not included in the "Client PC Service" list.
Port Range	Enter the port range for the service not included in the "Client PC Service" list. Enter a single port number e.g. 110, a range of port numbers e.g. 110-120, or multiple port numbers separated by a comma e.g. 110,115,120.
Add	Click "Add" to add selected services or a user defined service to the IP filtering table.

IP filtering entries will be listed in the IP filtering table shown below.

Enable IP Filtering Table : Deny Allow

IP Filtering Table :

NO	Client PC Description	Client PC IP Address	Client Service	Protocol	Port Range	Select
1	Home	192.168.2.115	TCP, UDP			<input type="checkbox"/>

Delete Selected/ Delete All	Delete selected or all entries from the table.
--	--

III-3-7-3. DMZ

A Demilitarized Zone (DMZ) is an isolated area in your local network where private IP addresses are mapped to specified Internet IP addresses, allowing unrestricted access to the private IP addresses but not to the wider local network.

You can define a virtual DMZ host here. This is useful for example, if a network client PC cannot run an application properly from behind an NAT firewall, since it opens the client up to unrestricted two-way access.

Enable DMZ	Check/uncheck the box to enable/disable the device's DMZ function.
Public	Select "Dynamic IP" or "Static IP" here. For "Dynamic IP" select an Internet connection session from dropdown menu. For "Static IP" enter the IP address that you want to map to a specific private IP address.
Client PC	Enter the private IP address that the internet IP address will be mapped to.
Computer Name	Select a computer name from the list and click "<<" to enter its IP address into the "Client PC" field (above).
Add	Click "Add" to add the client to the "Current DMZ Table".

DMZ entries will be displayed in the table shown below:

Current DMZ Table :

NO	Computer Name	Public IP Address	Client PC IP Address	Select
----	---------------	-------------------	----------------------	--------

Delete Selected/ Delete All	Delete selected or all entries from the table.
--	--

III-3-7-4. DoS

Denial-of-Service (DoS) is a common form of malicious attack against a network. The router's firewall can protect against such attacks.

If you are not familiar with these functions, it is recommended you keep the default settings.

DoS

Ping of Death 5 Ping of Death Packet(S) Per Second Burst 5

Discard Ping From WAN

Port Scan

- NMAP FIN / URG / PSH
- Xmas tree
- Another Xmas tree
- Null scan
- SYN / RST
- SYN / FIN
- SYN (only unreachable ports)

Sync Flood 30 Packet(S) Per Second Burst 30

Ping of Death	Specify the frequency of ping of death packets which will trigger the router's DoS protection function.
Discard Ping from WAN	Check this box and the router will not answer ping requests from the Internet.
Port Scan	Intruders use "port scanners" to detect open Internet IP address ports. Check each type of port scan to prevent.
Sync Flood	Specify the frequency of sync flood packets which will trigger the DoS protection function.

III-3-8. QoS



Quality of Service (QoS) is a feature to manage Internet bandwidth efficiently. Some applications require more bandwidth than others to function properly, and QoS allows you to ensure that sufficient bandwidth is available. Minimum or maximum bandwidth can be guaranteed for a specified application.



QoS can improve the BR-6478 AC V2's performance. QoS is recommended to optimize performance for online gaming.

III-3-8-1. QoS

Check/uncheck the box “Enable QoS” to enable/disable the QoS function. Click “Add” to open a new window and setup a QoS rule. The “Current QoS Table” displays all QoS rules.

QoS

Enable QoS

Total Download Bandwidth kbits

Total Upload Bandwidth kbits

Current QoS Table :

Priority	Rule Name	Upload Bandwidth	Download Bandwidth	Select
No data available in table				

Total Download Bandwidth	Enter your total download bandwidth limit from your Internet service provider (ISP) in kbits.
Total Upload Bandwidth	Enter your total upload bandwidth limit from your Internet service provider (ISP) in kbits.
Add	Opens a new window to add a new QoS rule to the current QoS table.

QoS

This page allows users to add/modify the QoS rule's settings.

Rule Name

Bandwidth kbits

Local IP Address -

Local Port Range

Remote IP Address -

Remote Port Range

Traffic Type

Protocol

Rule Name	Enter a name for the QoS rule for reference/identification.
Bandwidth	<p>Set the bandwidth limits for the QoS rule:</p> <div style="border: 1px solid black; padding: 5px; margin: 10px 0;"> Bandwidth : <input type="text" value="Download"/> <input type="text"/> Kbps <input type="text" value="guarantee"/> </div> <p style="text-align: center;">(1) (2) (3)</p> <ol style="list-style-type: none"> 1. Select "Download" or "Upload" for the QoS rule. 2. Enter the bandwidth limit. 3. Select whether the bandwidth is a "Guarantee" (minimum) or "Max" (maximum).
Local IP Address	<p>Enter the IP address range to which the QoS rule will be applied.</p> <p>Enter a starting IP address in the left field and the end IP address in the right field to define a range of IP addresses; or enter an IP address in the left field only to define a single IP address.</p>

Local Port Range	Enter the port range to activate the QoS rule. Enter a single port number e.g. 110 or a range of port numbers e.g. 110-120
Remote IP Address	Enter the remote IP address range which will activate the QoS rule. Enter a starting IP address in the left field and the end IP address in the right field to define a range of IP addresses; or enter an IP address in the left field only to define a single IP address.
Remote Port Range	Enter the remote port range to activate the QoS rule. Enter a single port number e.g. 110 or a range of port numbers e.g. 110-120
Traffic Type	Select traffic type as an alternative to specifying a port range above.
Protocol	Select a "TCP" or "UDP" protocol type.
Save	Click 'add' button to add a new QoS rule (detailed instructions will be given below).

QoS rule entries will be listed in the "Current QoS Table" as shown below. Select a rule using the "Select" checkbox.



When using the "Edit" button only one rule can be selected each time.



QoS rules will be processed in the order that they are listed i.e. the rule at the top of the list will be applied first, and then the second rule etc. The order can be adjusted using the "Move Up/Down" buttons.

Current QoS Table :

Priority	Rule Name	Upload Bandwidth	Download Bandwidth	Select
Add Edit Delete Selected Delete All Move Up Move Down				

Edit	Edit a selected rule.
Delete Selected/ Delete All	Delete selected or all entries from the table.
Move Up/Down	Move selected rule up or down the list.

III-3-8-2. iQoS

iQoS is a more intuitive and automated tool to manage internet bandwidth than manually configuring the settings using QoS. For online gamers or users with bandwidth requirements for audio/video, iQoS is a useful function.



iQoS cannot be used in conjunction with QoS and vice-versa. When one is enabled, the other is automatically disabled.

iQoS

iQoS is a smart tool for bandwidth management. iQoS cannot be used simultaneously with QoS.

Enable iQoS

Total Download Bandwidth kbits
Total Upload Bandwidth kbits

Current iQoS Table :

High		Low	

Settings have been saved. Please [click here to restart](#) the router and bring the new settings into effect.

Check/uncheck the box “Enable iQoS” to enable/disable the iQoS function, and then enter your bandwidth limits and arrange the network application icons in priority order in the “Current iQoS Table”. Icons with higher priority will be assigned bandwidth more efficiently for better performance.

Total Download Bandwidth	Enter your total download bandwidth limit from your Internet service provider (ISP) in kbits.
Total Upload Bandwidth	Enter your total upload bandwidth limit from your Internet service provider (ISP) in kbits.

The icons represent the following categories:



Internet Browsing



P2P/BT Downloads



FTP



Multimedia



Online Gaming

The iQoS table is ordered left to right, high to low priority. Click a small icon below the table to insert it into the table, and click a large icon in the table to remove it. All spaces in the priority table must be filled.

III-3-9. Advanced

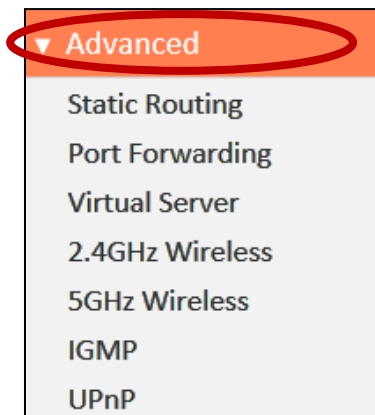

Advanced features of the BR-6478 AC V2 can be configured from the “Advanced” menu.

III-3-9-1. Static Routing

Static routing is a method of configuring path selection of routers, characterized by the absence of communication between routers regarding the current topology of the network. The opposite of static routing is dynamic routing, sometimes also referred to as adaptive routing.

You can configure static routing and manually add routes to the routing table shown below.

Static Routing

Enable Static Routing

Destination LAN IP Subnet Mask Default Gateway Hop Count Interface

 LAN ▼

Current Static Routing Table :

NO	Destination LAN IP	Subnet Mask	Default Gateway	Hop Count	Interface	Select
No data available in table						

Enable Static Routing	Check/uncheck the box to enable/disable static routing.
Destination LAN IP	Enter the destination network's IP address.
Subnet Mask	Enter the subnet mask of the destination network.
Default Gateway	Enter the default gateway of the destination network.
Hop Count	Enter the hop count (the distance between destination network and this broadband router) here.
Interface	Enter the interface which leads to destination network.
Add	Add the route to the current static routing table.

Static Routing Table entries will be displayed in the table shown below:

Current Static Routing Table :						
NO	Destination LAN IP	Subnet Mask	Default Gateway	Hop Count	Interface	Select
						<input type="button" value="Delete Selected"/> <input type="button" value="Delete All"/>

Delete Selected/ Delete All	Delete selected or all entries from the table.
--	--

III-3-9-2. Port Forwarding

This function allows you to redirect a single port or consecutive ports of an Internet IP address to the same port of a local IP address. The port number(s) of the Internet IP address and local IP address must be the same.

If the port number of the Internet IP address and local IP address is different, please use the "Virtual Server" function instead.

Port Forwarding

Enable Port Forwarding

Private IP Computer Name Type Port Range Comment

 << ----Select---- Both -

Add

Current Port Forwarding Table :

NO	Computer Name	Private IP	Type	Port Range	Comment	Select
No data available in table						

Delete Selected **Delete All**

Save Settings

Private IP	Enter the IP address of the computer on the local network.
Computer Name	Windows computers on the local network will be listed here – select a computer from the list and click << to automatically add the IP address to the “Private IP” field.
Type	Select the type of connection, “TCP”, “UDP” or “Both”.
Port Range	Input the starting port number in the left field, and input the ending port number in the right field. If you only want to redirect a single port number, only enter a port number in the left field.
Comment	Enter a comment for reference or identification.

Port Forwarding Table entries will be displayed in the table shown below:

Current Port Forwarding Table :

NO	Computer Name	Private IP	Type	Port Range	Comment	Select
Delete Selected Delete All						

Delete Selected/ Delete All	Delete selected or all entries from the table.
--	--

III-3-9-3. Virtual Server

This function allows you to set up an internet service on a local computer, without exposing the local computer to the internet. You can also build various sets of port redirection, to provide various internet services on different local computers via a single internet IP address.

Virtual Server

Enable Virtual Server

Private IP:

Computer Name: ----Select---- ▼

Private Port:

Type: Both ▼

Public Port:

Comment:

Current Virtual Server Table :

NO	Computer Name	Private IP	Private Port	Type	Public Port	Comment	Select
No data available in table							

Private IP	Specify the IP address of the computer on your local network.
Computer Name	Select the name of a Windows computer from the drop-down menu and click <input type="button" value="←"/> to auto-input its IP address in the "Private IP" field.
Private Port	Specify the private port you wish to use on the computer in your local network.
Type	Select the type of Internet Protocol.
Public Port	Specify a public port to access the computer on your local network.
Comment	Enter a comment for reference or identification.

Current Virtual Table entries will be displayed in the table shown below:

Current Virtual Server Table :

NO	Computer Name	Private IP	Private Port	Type	Public Port	Comment	Select
							<input type="button" value="Delete Selected"/> <input type="button" value="Delete All"/>

Delete Selected/ Delete All	Delete selected or all entries from the table.
--	--

III-3-9-4. 2.4GHz Wireless

These settings are for experienced users only. Please do not change any of the values on this page unless you are already familiar with these functions.

2.4GHz Wireless

Wireless Module	Enable
Fragment Threshold	<input type="text" value="2346"/> (256-2346)
RTS Threshold	<input type="text" value="2347"/> (0-2347)
Beacon Interval	<input type="text" value="100"/> (20-1024 ms)
DTIM Period	<input type="text" value="3"/> (1-10)
Data Rate	Auto ▾
N Data Rate	Auto ▾
Channel Width	<input checked="" type="radio"/> Auto 20/40 MHz <input type="radio"/> 20 MHz
Preamble Type	<input checked="" type="radio"/> Short Preamble <input type="radio"/> Long Preamble
CTS Protect	<input type="radio"/> Auto <input type="radio"/> Always <input checked="" type="radio"/> None
Tx Power	100% ▾
WMM	<input checked="" type="radio"/> Enable <input type="radio"/> Disable

Fragment Threshold	Set the Fragment threshold of the wireless radio. The default value is 2346.
RTS Threshold	Set the RTS threshold of the wireless radio. The default value is 2347.
Beacon Interval	Set the beacon interval of the wireless radio. The default value is 100.

DTIM Period	Set the DTIM period of wireless radio. The default value is 3.
Data Rate	Set the wireless data transfer rate. The default is set to Auto.
N Data Rate	Set the data rate of 802.11n. The default is set to Auto.
Channel Width	Select wireless channel width (bandwidth used by wireless signals from the device) – the recommended value is Auto 20/40MHz.
Preamble Type	Set the wireless radio preamble type. The default value is “Short Preamble”.
CTS Protect	Enabling this setting will reduce the chance of radio signal collisions between 802.11b and 802.11g wireless access points. It’s recommended to set this option to “Auto”.
Tx Power	Set the power output of the wireless radio. You may not require 100% output power. Setting a lower power output can enhance security since potentially malicious/unknown users in distant areas will not be able to access your signal.
WMM	WMM (Wi-Fi Multimedia) technology can improve the performance of certain network applications, such as audio/video streaming, network telephony (VoIP) and others. When WMM is enabled, the device will prioritize different kinds of data and give higher priority to applications which require instant responses for better performance.

III-3-9-5. 5GHz Wireless

These settings are for experienced users only. Please do not change any of the values on this page unless you are already familiar with these functions.

5GHz Wireless

Wireless Module	Enable
Fragment Threshold	<input type="text" value="2346"/> (256-2346)
RTS Threshold	<input type="text" value="2347"/> (0-2347)
Beacon Interval	<input type="text" value="100"/> (20-1024 ms)
DTIM Period	<input type="text" value="3"/> (1-10)
Data Rate	<input type="text" value="Auto"/> ▼
N Data Rate	<input type="text" value="Auto"/> ▼
Channel Width	<input checked="" type="radio"/> 20/40/80 MHz <input type="radio"/> 20/40 MHz <input type="radio"/> 20 MHz
Preamble Type	<input checked="" type="radio"/> Short Preamble <input type="radio"/> Long Preamble
CTS Protect	<input type="radio"/> Auto <input type="radio"/> Always <input checked="" type="radio"/> None
Tx Power	<input type="text" value="100%"/> ▼
WMM	<input checked="" type="radio"/> Enable <input type="radio"/> Disable

Fragment Threshold	Set the Fragment threshold of the wireless radio. The default value is 2346.
RTS Threshold	Set the RTS threshold of the wireless radio. The default value is 2347.
Beacon Interval	Set the beacon interval of the wireless radio. The default value is 100.
DTIM Period	Set the DTIM period of wireless radio. The default value is 3.
Data Rate	Set the wireless data transfer rate. The default is set to Auto.
N Data Rate	Set the data rate of 802.11n. The default is set to Auto.

Channel Width	Select wireless channel width (bandwidth used by wireless signals from the device) – the recommended value is 20/40/80MHz.
Preamble Type	Set the wireless radio preamble type. The default value is “Short Preamble”.
CTS Protect	Enabling this setting will reduce the chance of radio signal collisions between 802.11b and 802.11g wireless access points. It’s recommended to set this option to “Auto”.
Tx Power	Set the power output of the wireless radio. You may not require 100% output power. Setting a lower power output can enhance security since potentially malicious/unknown users in distant areas will not be able to access your signal.
WMM	WMM (Wi-Fi Multimedia) technology can improve the performance of certain network applications, such as audio/video streaming, network telephony (VoIP) and others. When WMM is enabled, the device will prioritize different kinds of data and give higher priority to applications which require instant responses for better performance.

III-3-9-6. IGMP

IGMP is a communications protocol used to establish multicast group memberships. It allows for a more efficient use of resources and better performance for applications such as IPTV video streaming.

IGMP

IGMP Snooping Enable Disable

IGMP Proxy Enable Disable

Save Settings

IGMP Snooping	IGMP snooping monitors traffic between hosts and multicast routers to facilitate bandwidth conservation. Select enable or disable.
IGMP Proxy	IGMP proxy enables intelligent multicast forwarding based on IGMP snooping information. Select enable or disable.



It is recommended to set “IGMP Snooping” and “IGMP Proxy” to “Enable”.

III-3-9-7. UPnP

Universal plug-and-play (UPnP) is a set of networking protocols which enables network devices to communicate and automatically establish working configurations with each other. Select “Enable” or “Disable”.

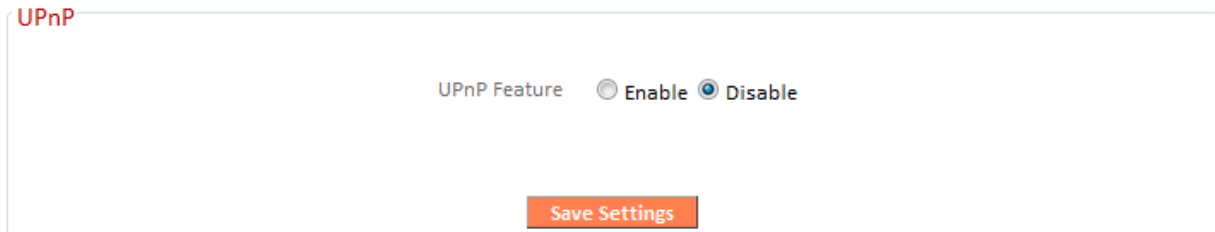

UPnP

UPnP Feature Enable Disable

Save Settings

III-3-9-8. Fast NAT

Enable or disable fast NAT (Network Address Translation) for better network performance.

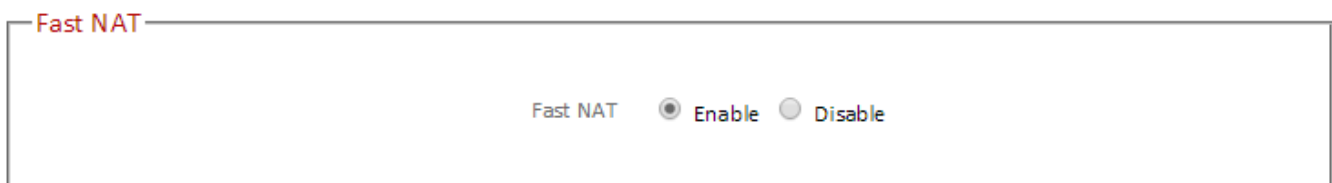

Fast NAT

Fast NAT Enable Disable

III-3-10. Administration

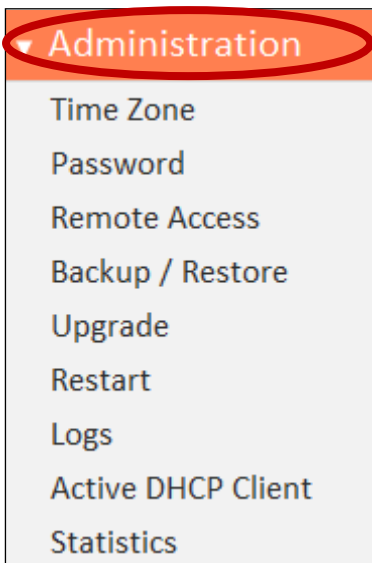

Various administrative functions can be accessed from the “Administration” menu.

III-3-10-1. Time Zone

Set Time Zone	Select the time zone of your country or region.
Time Server Address	The travel router supports NTP (Network Time Protocol) for automatic time and date setup. Input the host name of the IP server manually.
Daylight Saving	If your country/region uses daylight saving time, please check the “Enable Function” box, and select the start and end date.

III-3-10-2. Password

You can change the password used to login to the browser-based configuration interface here. It is advised to do so for security purposes.



Please make a note of the new password. In the event that you forget the password and are unable to login to the browser based configuration interface, see [II-7. Reset to factory default settings](#) for how to reset the device.

Password

Current Password

New Password

Confirmed Password

Apply

Current Password	Enter your current password.
New Password	Enter your new password.
Confirmed Password	Confirm your new password.

III-3-10-3. Remote Access

Check “Enabled” to enable the remote access feature and then enter the appropriate values.

Remote Access

Host IP Address

Port

Enabled

[Save Settings](#)

Host IP Address	Specify the IP address which is allowed remote access.
Port	Specify a port number (0–65535) used for remote access.

III-3-10-4. Backup/Restore

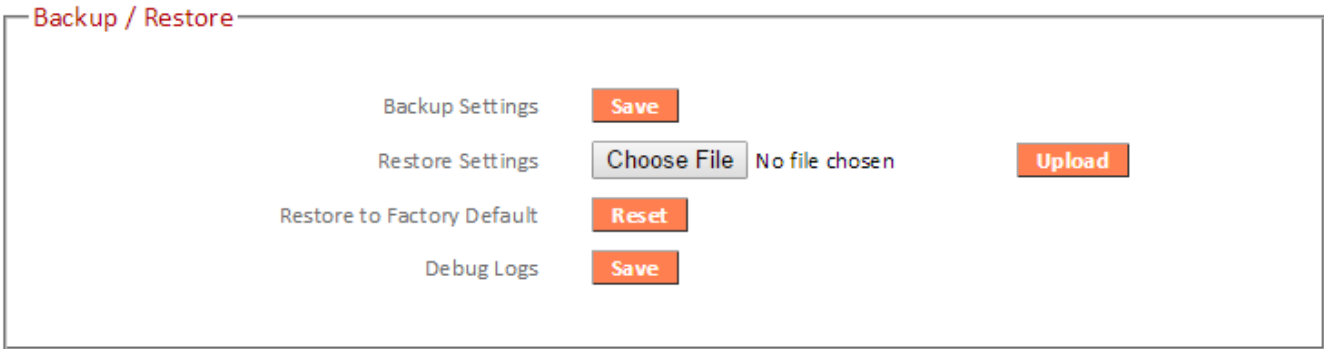

Backup Settings	Click “Save” to save the current settings on your computer as config.bin file.
Restore Settings	Click “Browse” to find a previously saved config.bin file and then click “Upload” to replace your current settings.
Restore to Factory Default	Click “Reset” to restore settings to the factory default. A pop-up window will appear and ask you to confirm and enter your log in details. Enter your username and password and click “Ok”. See below for more information.
Debug Logs	Click to save a log file of wireless information to your computer as a .txt file.

III-3-10-5. Upgrade

The upgrade page displays the current firmware version and allows you to upgrade the system firmware to a more recent version. You can download the latest firmware from the Edimax website and upgrade manually using the **Choose File** button or you can click the **Check the latest version** button to check your version and automatically upgrade if a newer version is available. After the upgrade, the system will restart.



Do not switch off or disconnect the device during a firmware upgrade, as this could damage the device. It is recommended that you use a wired Ethernet connection for a firmware upgrade and that you backup your existing firmware before upgrading.

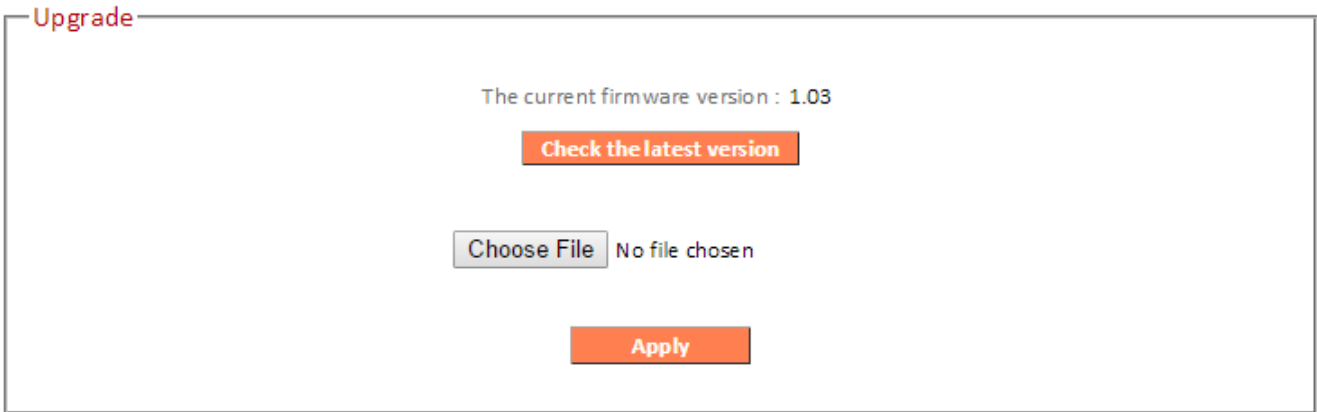

III-3-10-6. Restart

In the event that the router malfunctions or is not responding, then it is recommended that you restart the device.

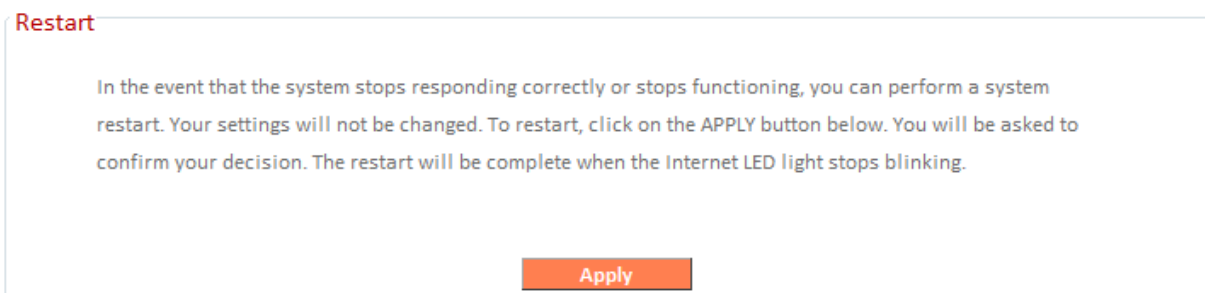

III-3-10-7. Logs

You can view the system log and security log here. Use the drop down menu in the top-right corner to select which log to view.

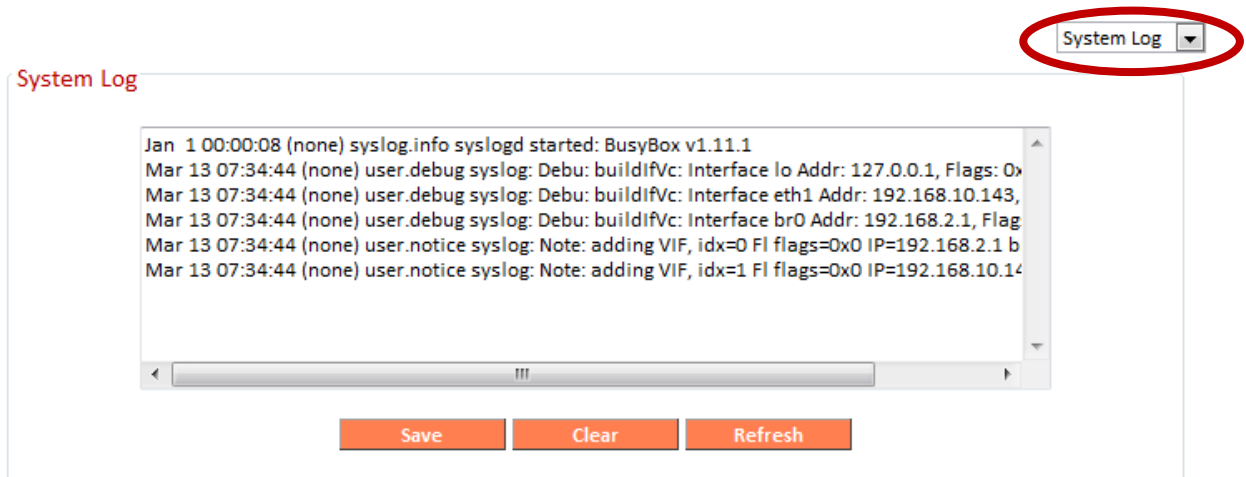

Security Log

```
[1970-01-01 00:00:22]: start Dynamic IP
[1970-01-01 00:00:24]: [SNTP]: connect to TimeServer 59.124.196.84 ...
[2014-03-13 07:34:33]: [SNTP]: connect success!
[2014-03-13 07:34:33]: [SNTP]: set time to 2014-03-13 07:34:33
[2014-03-13 07:34:34]: [Firewall]: WAN1 IP is 192.168.10.143
[2014-03-13 07:34:34]: [Firewall]: WAN2 IP is 0.0.0.0
[2014-03-13 07:34:34]: [Firewall]: WAN3 IP is 0.0.0.0
[2014-03-13 07:34:34]: [Firewall]: setting firewall...
[2014-03-13 07:34:36]: [SNTP]: connect to TimeServer 59.124.196.84 ...
```

Save Clear Refresh

Save	Click “Save” to save the log on your computer as .txt file.
Clear	Click “Clear” to clear/erase the existing log.
Refresh	Click “Refresh” to refresh the log and update any activity.

III-3-10-8. Active DHCP Client

Information about active DHCP clients is shown in the table, which displays the DHCP server assigned IP address, MAC address and time expired for each computer or device on the local network.

Active DHCP Client

IP Address	MAC Address	Time Expired (Sec)
192.168.2.100	bc:ee:7b:4b:fa:3a	forever
192.168.2.101	f8:a9:d0:0b:7d:a8	forever
192.168.2.102	80:1f:02:9c:8f:ff	forever

[Refresh](#)

III-3-10-9. Statistics

Displays sent and received packet network statistics.

Statistics

2.4GHz Wireless	Sent Packets	36553
	Received Packets	27058
5GHz Wireless	Sent Packets	2924
	Received Packets	756
Ethernet LAN	Sent Packets	3225
	Received Packets	0
Ethernet WAN	Sent Packets	25951
	Received Packets	34267

[Refresh](#)

IV. Appendix

IV-1. Configuring your IP address

For first time access to the URL ***http://edimax.setup*** please ensure your computer is set to use a dynamic IP address. This means your computer can obtain an IP address automatically from a DHCP server. You can check if your computer is set to use a dynamic IP address by following [IV-1-1. How to check that your computer uses a dynamic IP address.](#)

Static IP users can also temporarily modify your computer's IP address to be in the same IP address subnet e.g. **192.168.2.x (x = 3 – 254)** as the BR-6478 AC V2 in order to access ***http://edimax.setup***.



The BR-6478 AC V2's default IP address is 192.168.2.1.

The procedure for modifying your IP address varies across different operating systems; please follow the guide appropriate for your operating system in [IV-1-2. How to modify the IP address of your computer.](#)



Static IP users please make a note of your static IP before you change it.

You can assign a new IP address to the device which is within the subnet of your network during setup or using the browser based configuration interface (refer to [III-3-4. LAN](#)). Then you can access the URL ***http://edimax.setup*** in future without modifying your IP address.



Please remember to change your IP address back to its original value after the device is properly configured.

IV-1-1. How to check that your computer uses a dynamic IP address

Please follow the instructions appropriate for your operating system.

IV-1-1-1. Windows XP

1. Click the “Start” button (it should be located in the lower-left corner of your computer), then click “Control Panel”. Double-click the “Network and Internet Connections” icon, click “Network Connections”, and then double-click “Local Area Connection”. The “Local Area Connection Status” window will then appear, click “Properties”.

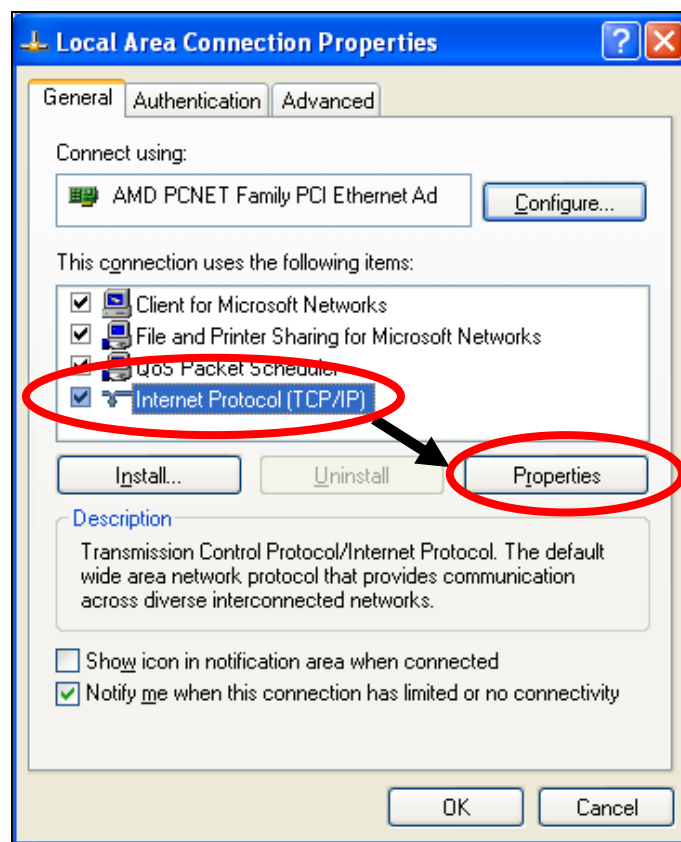

2. “Obtain an IP address automatically” and “Obtain DNS server address automatically” should be selected.

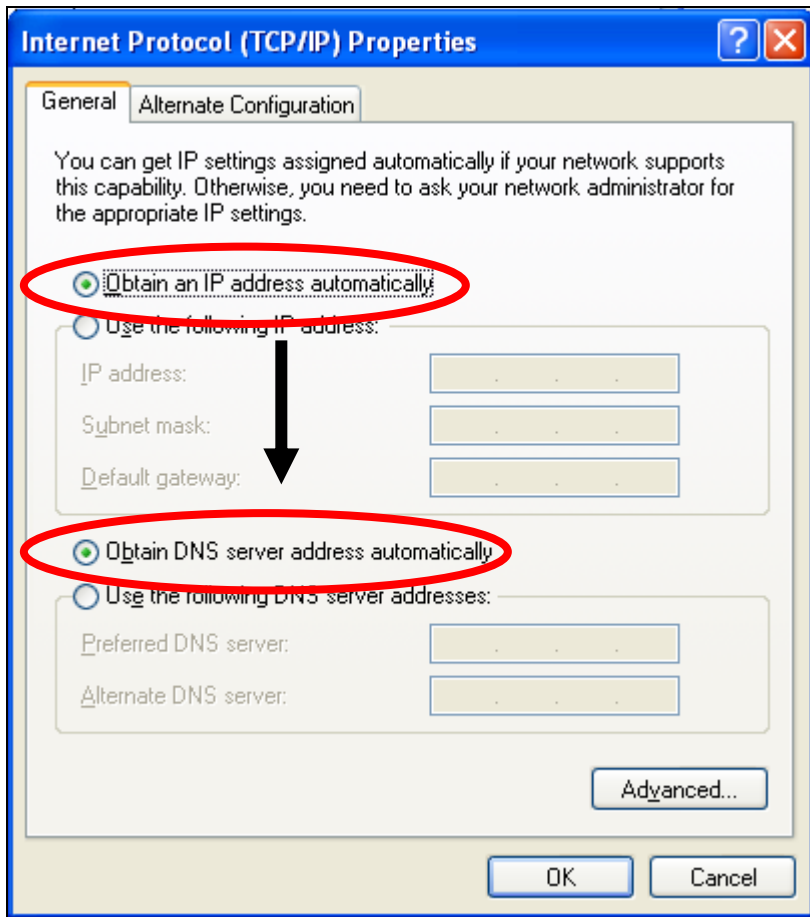

IV-1-1-2. Windows Vista

1. Click the “Start” button (it should be located in the lower-left corner of your computer), then click “Control Panel”. Click “View Network Status and Tasks”, then click “Manage Network Connections”. Right-click “Local Area Network”, then select “Properties”. The “Local Area Connection Properties” window will then appear, select “Internet Protocol Version 4 (TCP / IPv4)”, and then click “Properties”.

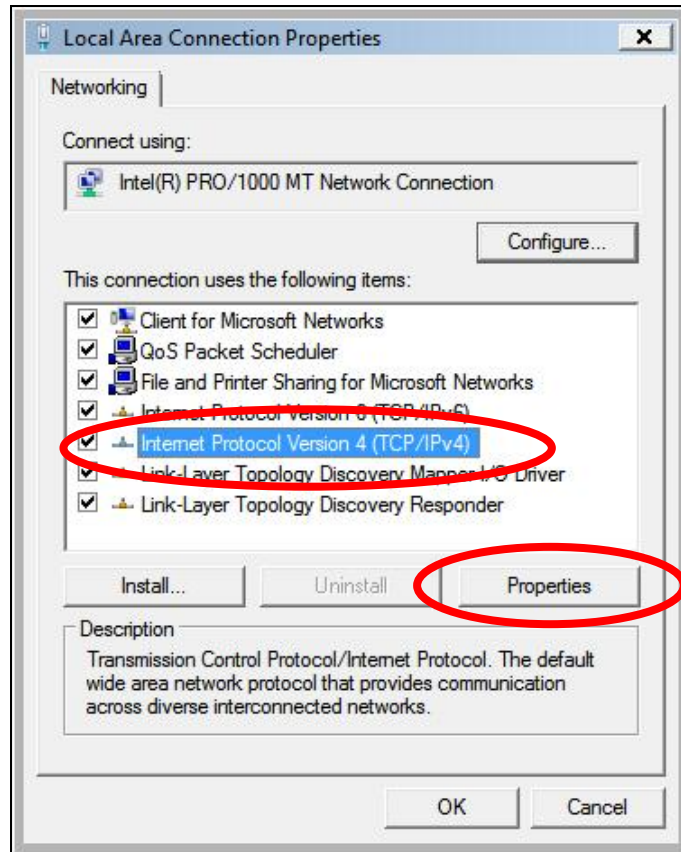

2. Select “Obtain an IP address automatically” and “Obtain DNS server address automatically” should be selected.

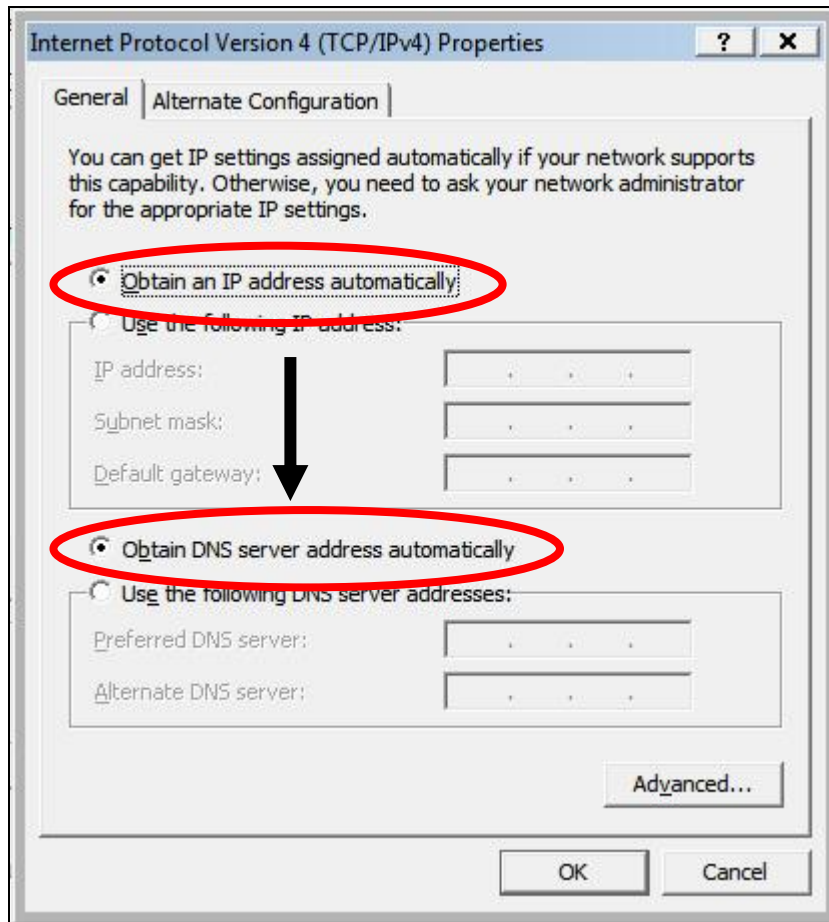

IV-1-1-3. Windows 7

1. Click the “Start” button (it should be located in the lower-left corner of your computer), then click “Control Panel”.

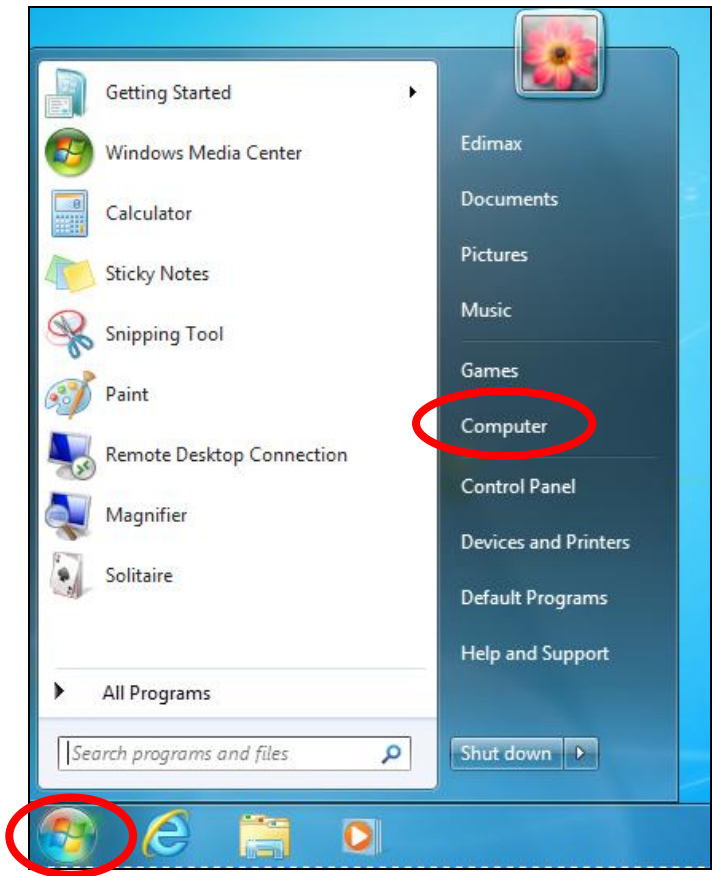

2. Under “Network and Internet” click “View network status and tasks”.

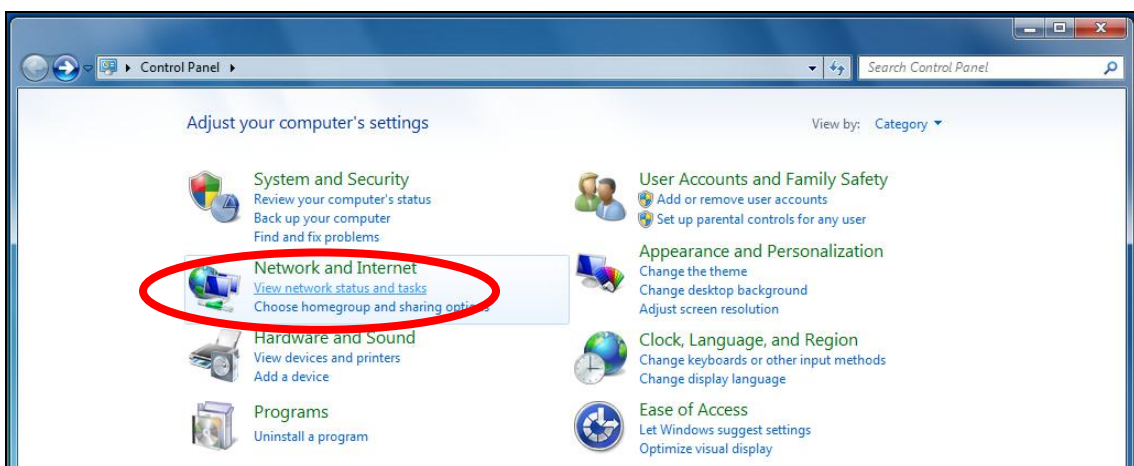

3. Click “Local Area Connection”.

View your basic network information and set up connections

TS-WIN7 (This computer) — Home network — ~~Internet~~ [See full map](#)

View your active networks [Connect or disconnect](#)

Home network
Home network

Access type: No Internet access
HomeGroup: Ready to create
Connections: **Local Area Connection**

4. Click “Properties”.

Local Area Connection Status

General

Connection

IPv4 Connectivity:	No Internet access
IPv6 Connectivity:	No network access
Media State:	Enabled
Duration:	02:08:52
Speed:	100.0 Mbps

[Details...](#)

Activity

	Sent	Received
Bytes:	951,332	4,398,184

[Properties](#) [Disable](#) [Diagnose](#) [Close](#)

5. Select “Internet Protocol Version 4 (TCP/IPv4) and then click “Properties”.

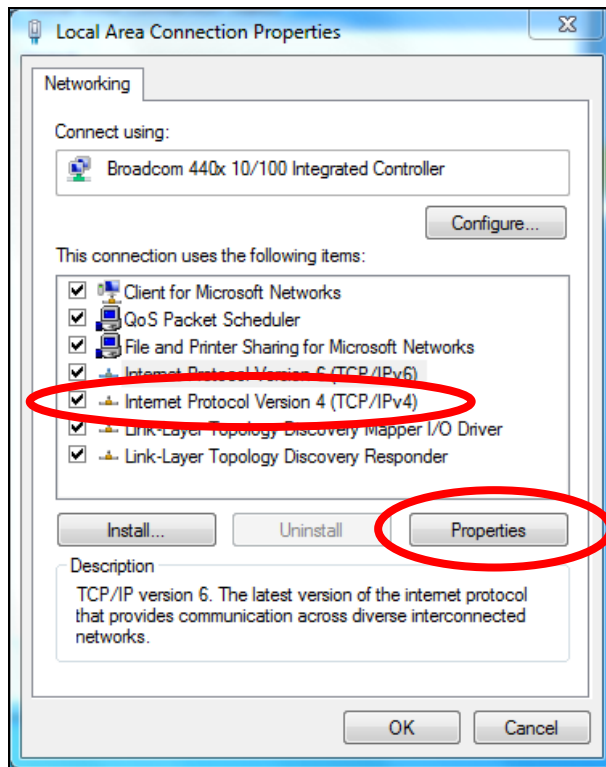

6. Select “Obtain an IP address automatically” and “Obtain DNS server address automatically” should be selected.

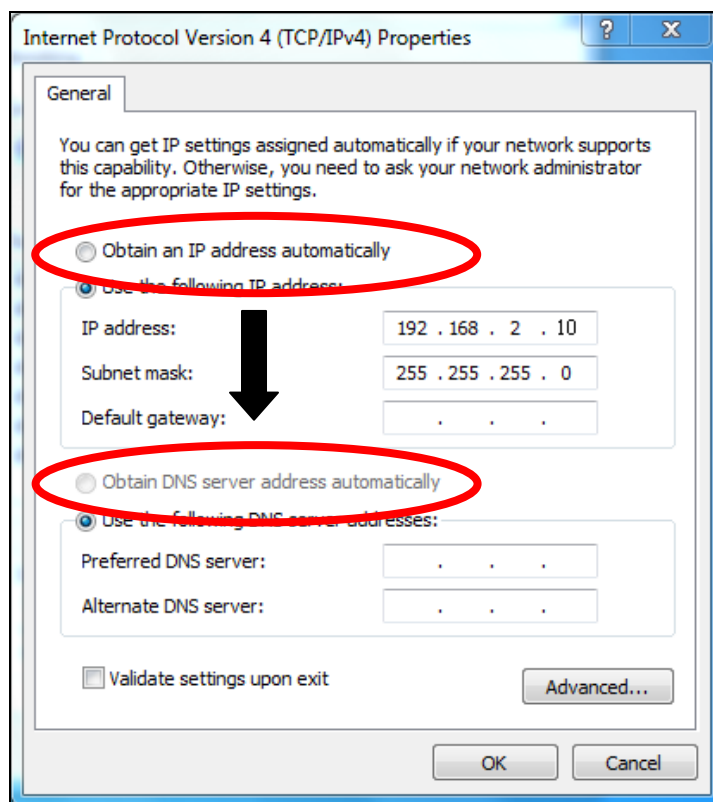

IV-1-1-4. Windows 8

1. From the Windows 8 Start screen, you need to switch to desktop mode. Move your cursor to the bottom left of the screen and click.

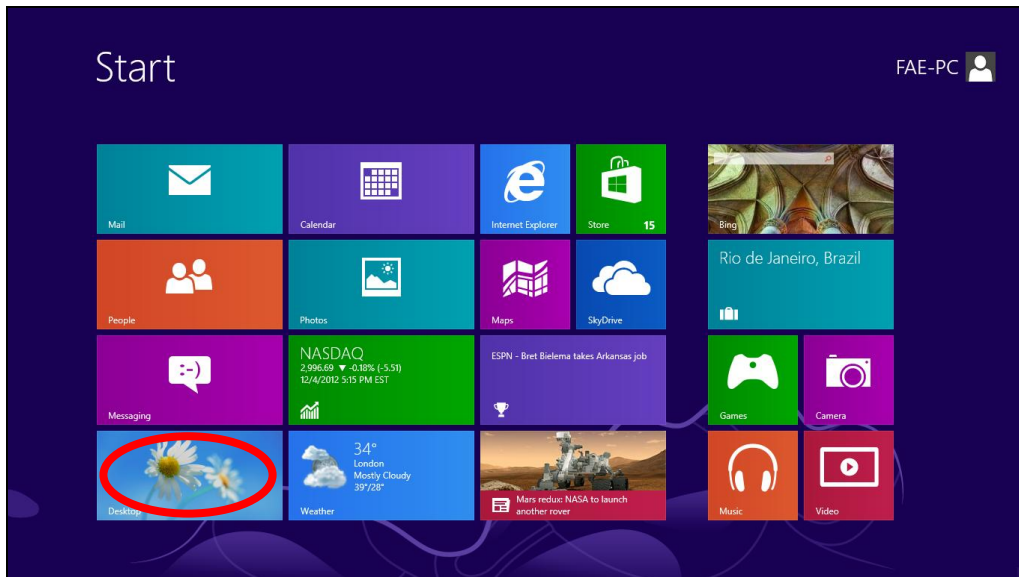

2. In desktop mode, click the File Explorer icon in the bottom left of the screen, as shown below.

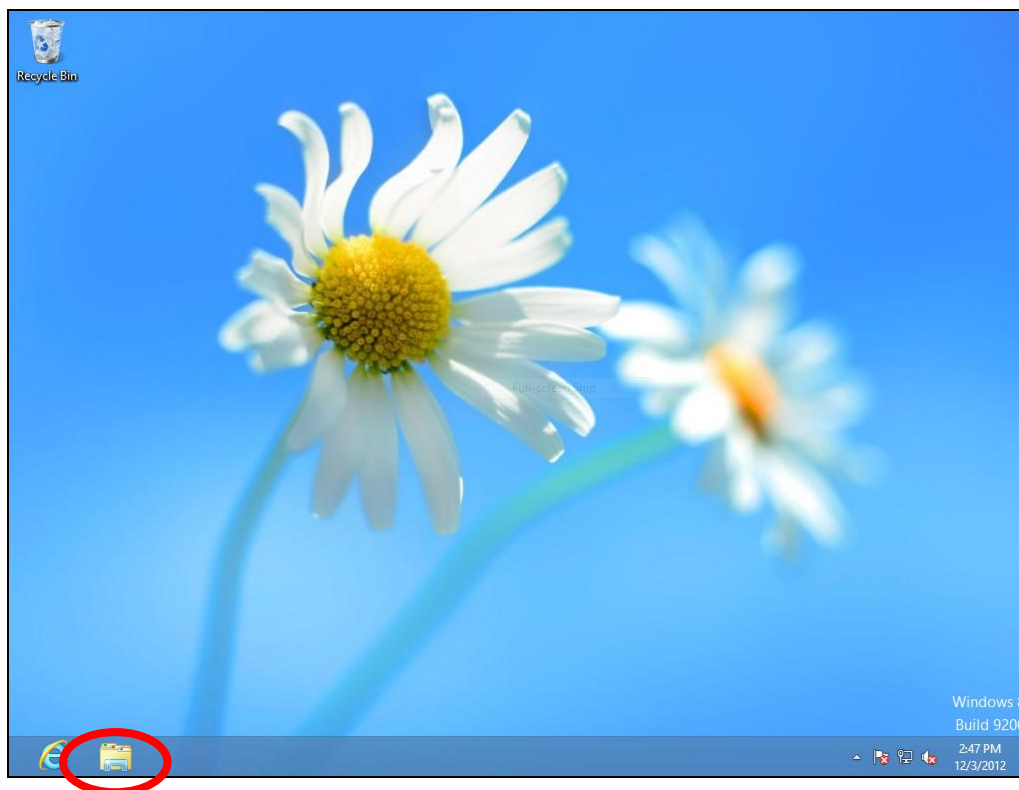

3. Right click "Network" and then select "Properties".

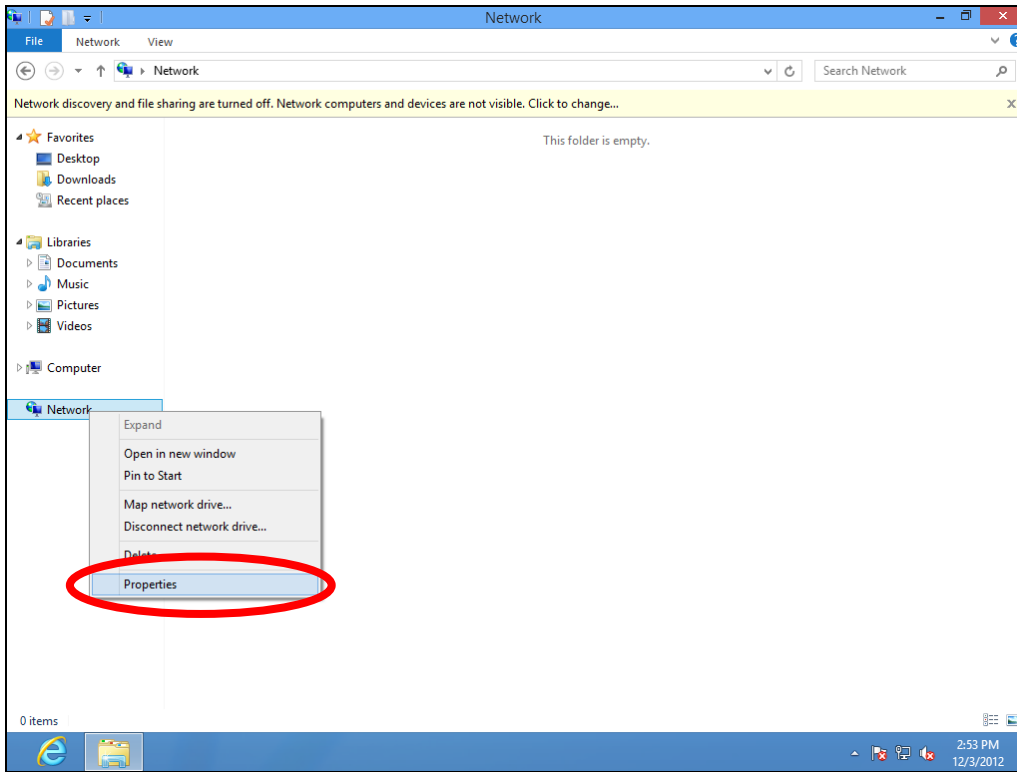

4. In the window that opens, select “Change adapter settings” from the left side.

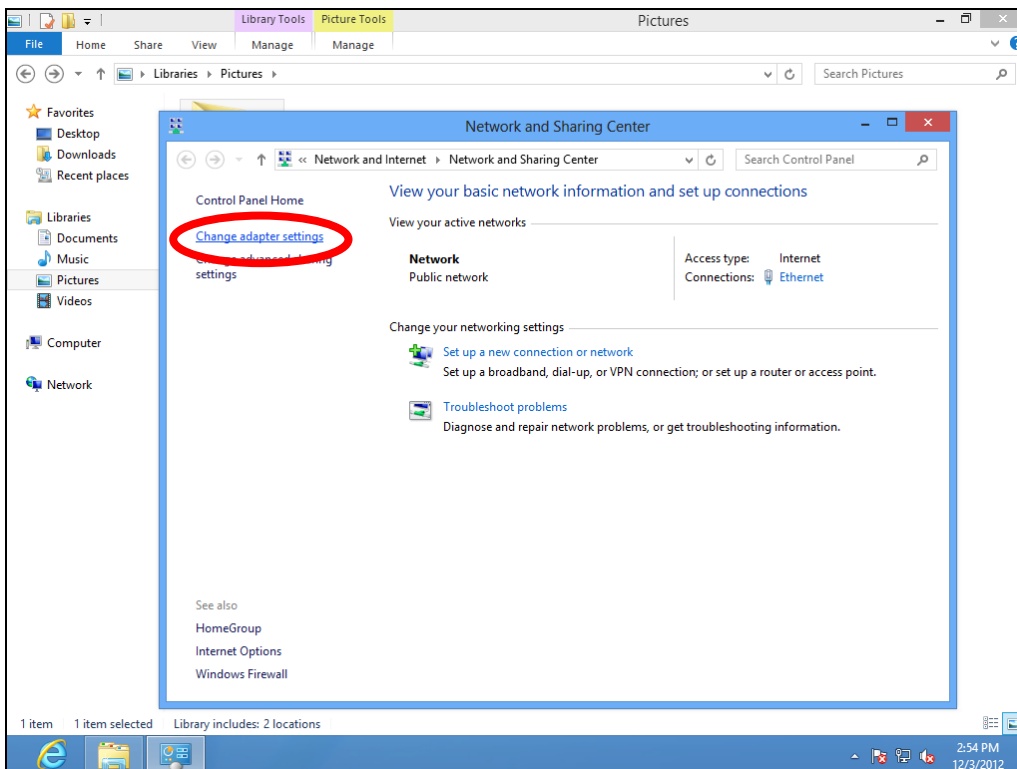

5. Choose your connection and right click, then select “Properties”.

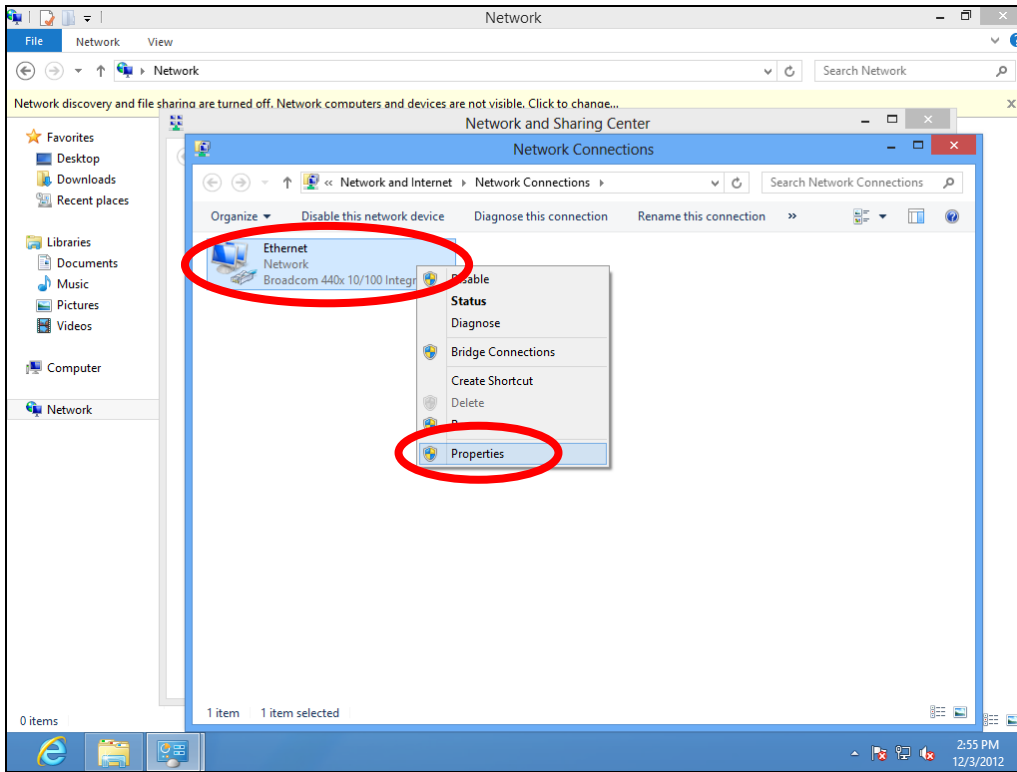

6. Select “Internet Protocol Version 4 (TCP/IPv4) and then click “Properties””.

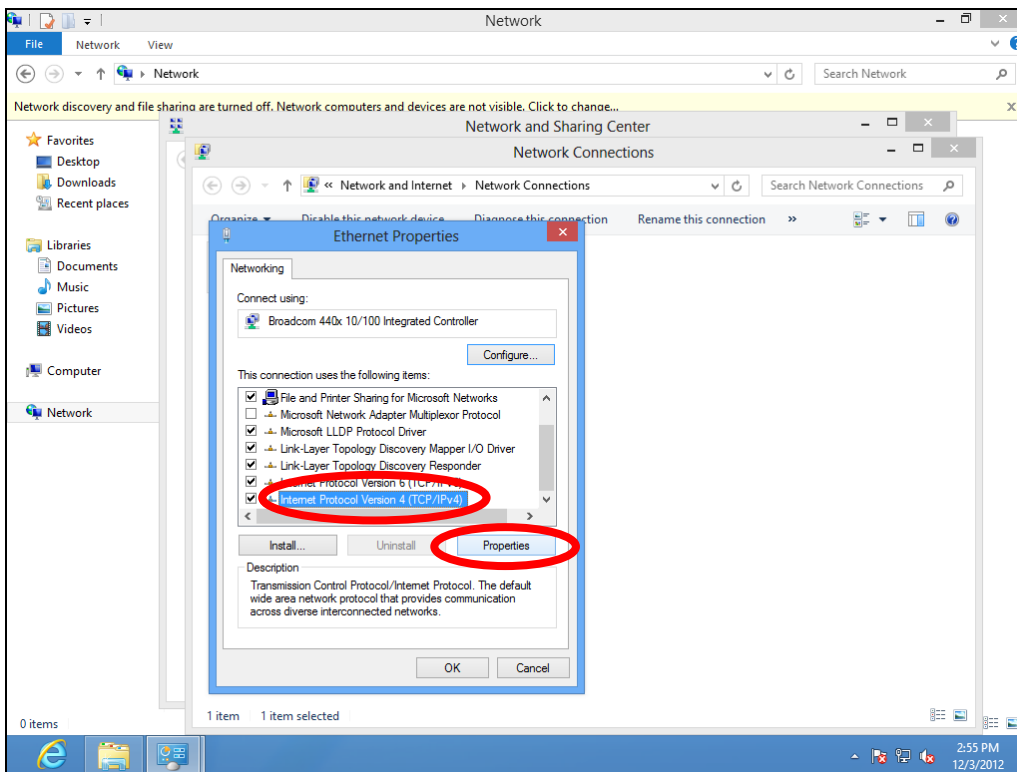

7. Select “Obtain an IP address automatically” and “Obtain DNS server address automatically” should be selected.

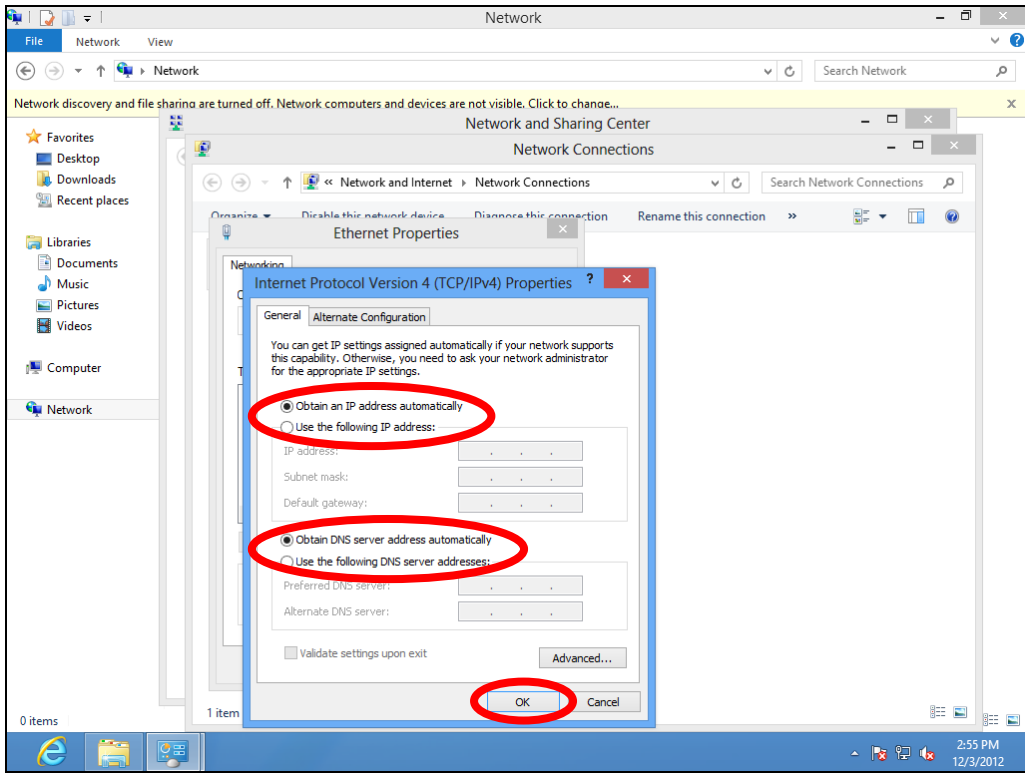

IV-1-1-5. Mac OS

1. Have your Macintosh computer operate as usual, and click on “System Preferences”.

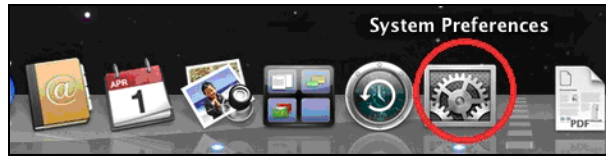

2. In System Preferences, click on “Network”.



3. Click on “Wi-Fi” in the left panel and then click “Advanced” in the lower right corner.

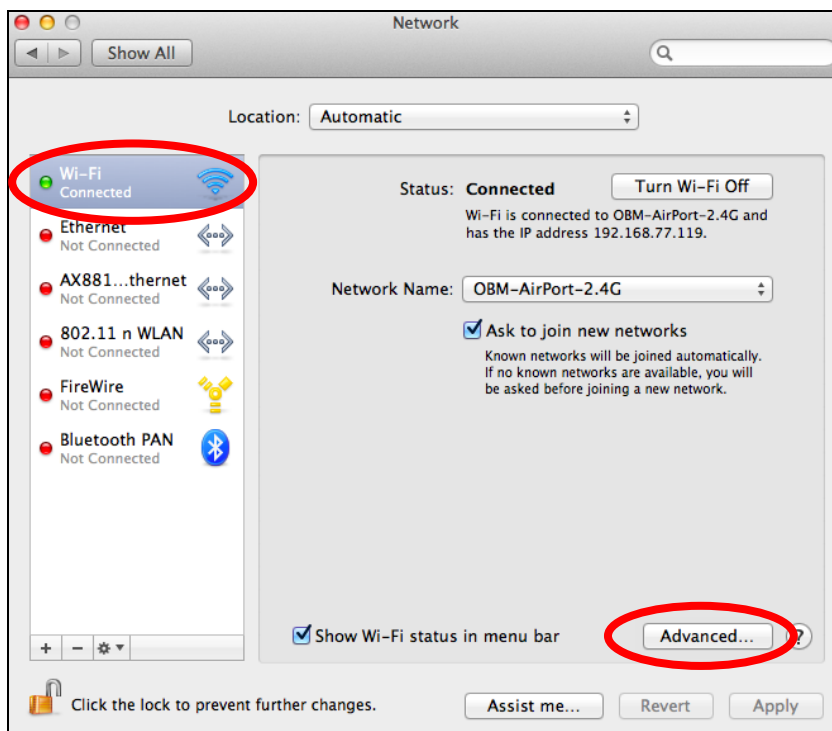

4. Select “TCP/IP” from the top menu and “Using DHCP” in the drop down menu labeled “Configure IPv4” should be selected.

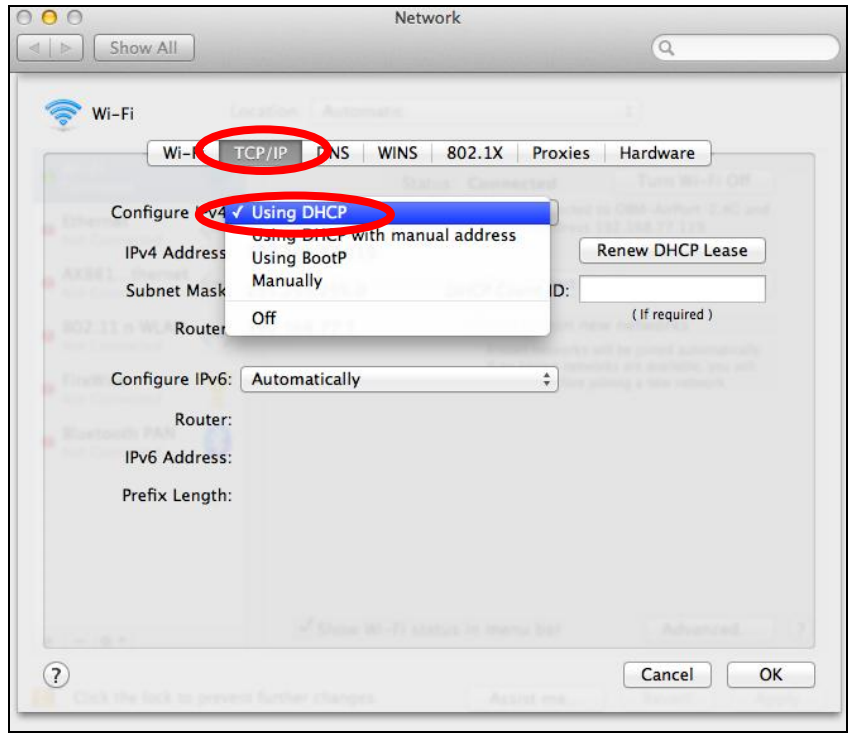

IV-1-2. How to modify the IP address of your computer

Please follow the instructions appropriate for your operating system. In the following examples we use the IP address **192.168.2.10** though you can use any IP address in the range **192.168.2.x (x = 3 – 254)** in order to access iQ Setup/browser based configuration interface.

 **Please make a note of your static IP before you change it.**

IV-1-2-1. Windows XP

1. Click the “Start” button (it should be located in the lower-left corner of your computer), then click “Control Panel”. Double-click the “Network and Internet Connections” icon, click “Network Connections”, and then double-click “Local Area Connection”. The “Local Area Connection Status” window will then appear, click “Properties”.

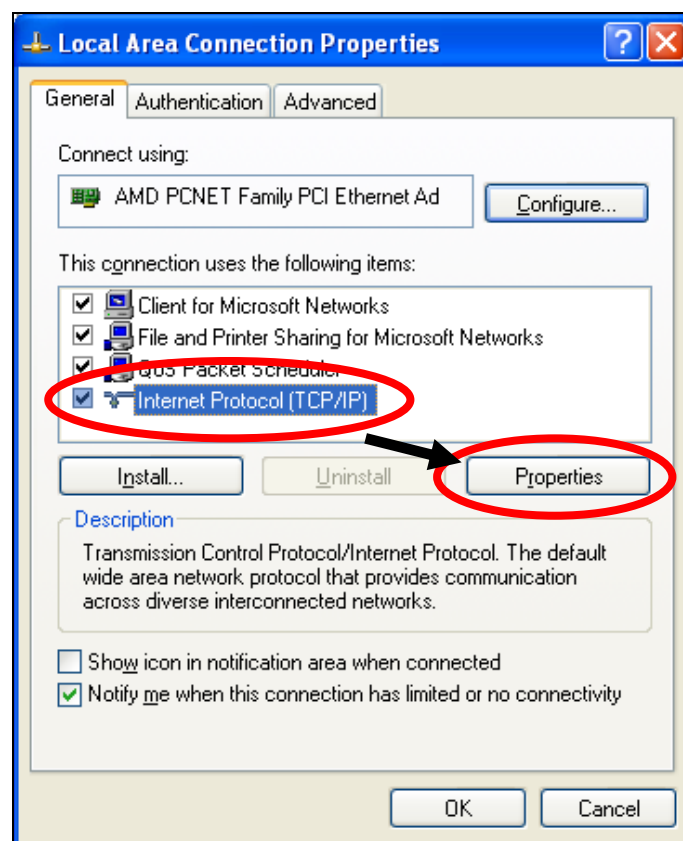

2. Select “Use the following IP address” and “Use the following DNS server addresses”, then input the following values:



Your existing static IP address will be displayed in the “IP address” field before you replace it. Please make a note of this IP address, subnet mask, default gateway and DNS server addresses.

IP address: 192.168.2.10

Subnet Mask: 255.255.255.0

Preferred DNS Server: 192.168.2.1

Click ‘OK’ when finished.

IV-1-2-2. Windows Vista

1. Click the “Start” button (it should be located in the lower-left corner of your computer), then click “Control Panel”. Click “View Network Status and Tasks”, then click “Manage Network Connections”. Right-click “Local Area Network”, then select “Properties”. The “Local Area Connection Properties” window will then appear, select “Internet Protocol Version 4 (TCP / IPv4)”, and then click “Properties”.

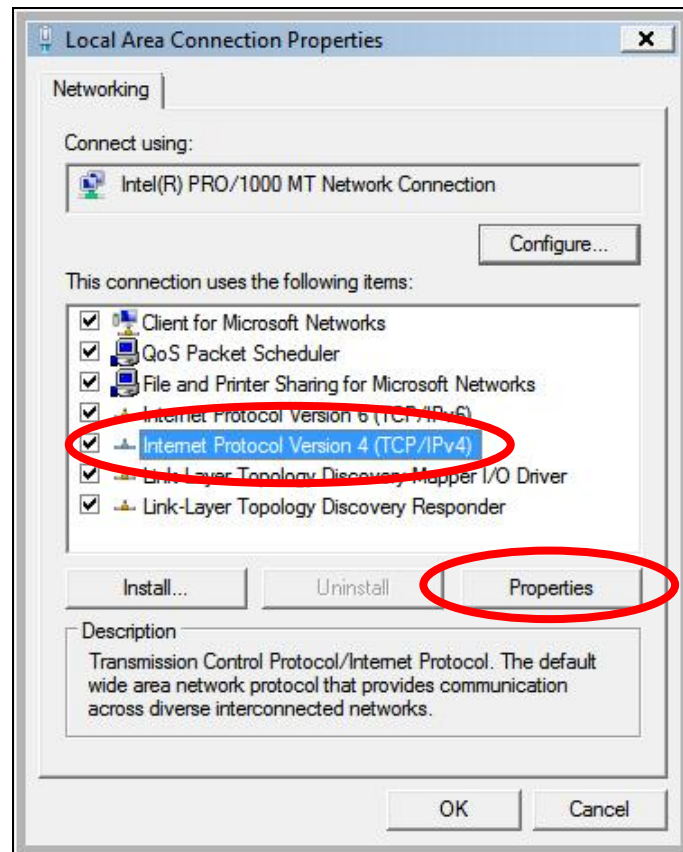

2. Select “Use the following IP address” and “Use the following DNS server addresses”, then input the following values:

 ***Your existing static IP address will be displayed in the “IP address” field before you replace it. Please make a note of this IP address, subnet mask, default gateway and DNS server addresses.***

IP address: 192.168.2.10

Subnet Mask: 255.255.255.0

Preferred DNS Server: 192.168.2.1

Click ‘OK’ when finished.

IV-1-2-3. Windows 7

1. Click the “Start” button (it should be located in the lower-left corner of your computer), then click “Control Panel”.

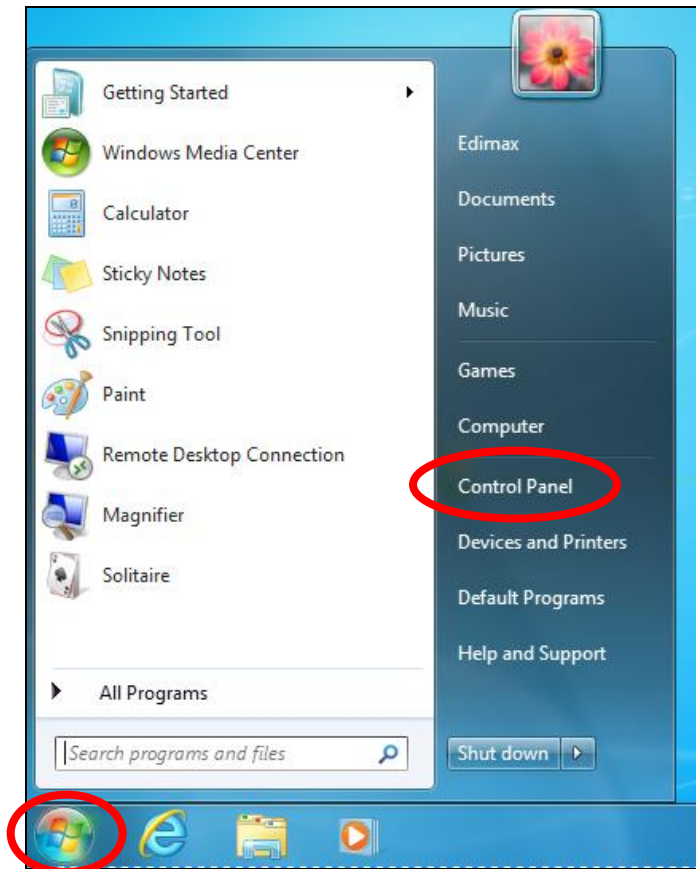

2. Under “Network and Internet” click “View network status and tasks”.

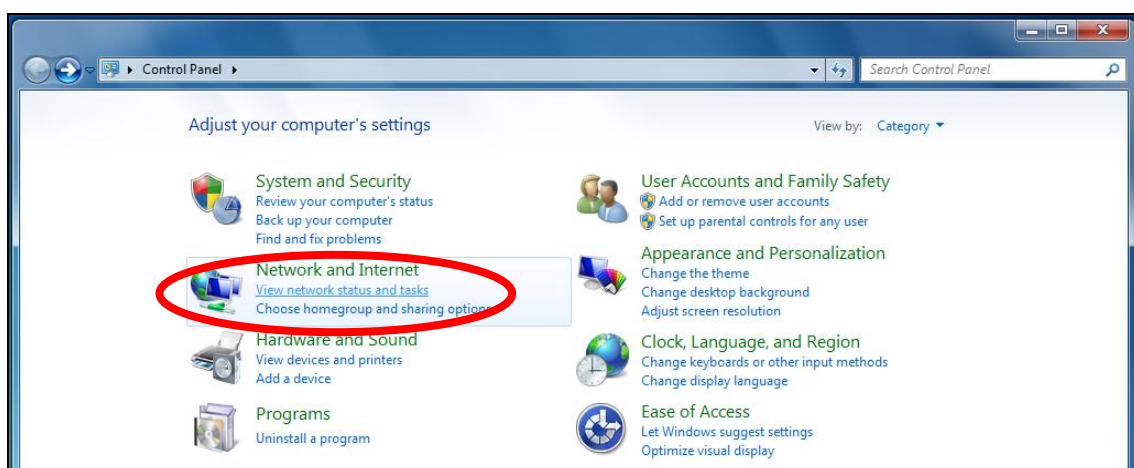

3. Click "Local Area Connection".

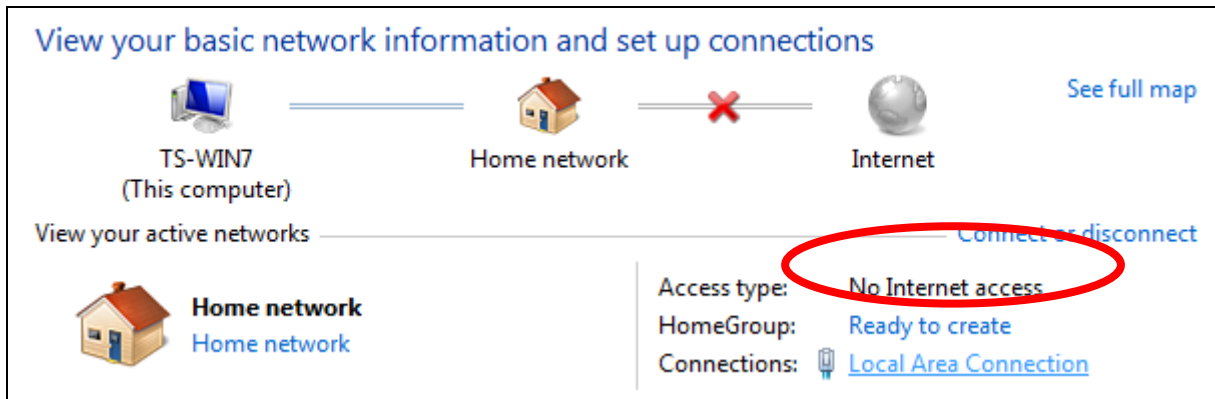

4. Click "Properties".

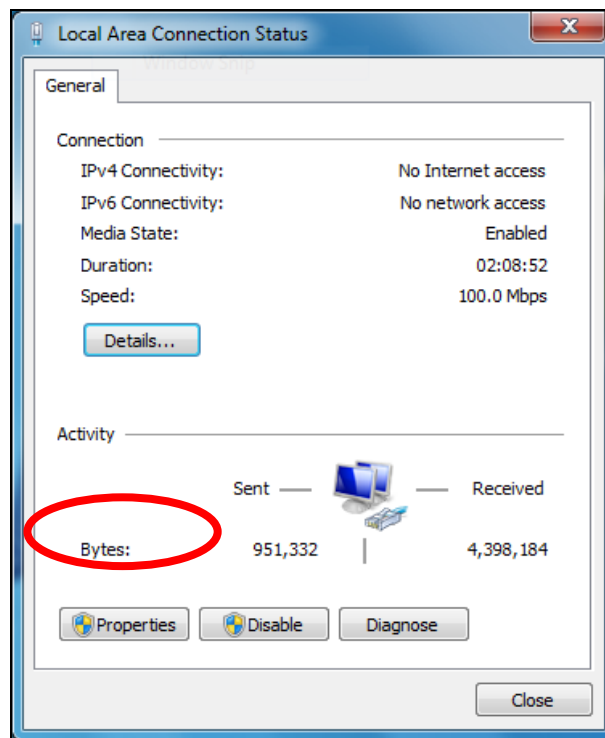

5. Select “Internet Protocol Version 4 (TCP/IPv4) and then click “Properties”.

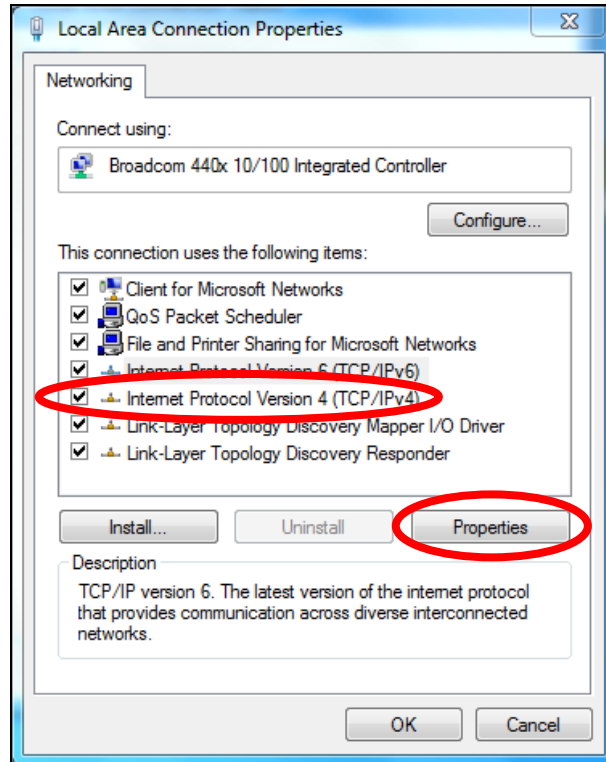

6. Select “Use the following IP address” and “Use the following DNS server addresses”, then input the following values:



Your existing static IP address will be displayed in the “IP address” field before you replace it. Please make a note of this IP address, subnet mask, default gateway and DNS server addresses.

IP address: 192.168.2.10

Subnet Mask: 255.255.255.0

Preferred DNS Server: 192.168.2.1

Click ‘OK’ when finished.

IV-1-2-4. Windows 8

1. From the Windows 8 Start screen, you need to switch to desktop mode. Move your cursor to the bottom left of the screen and click.

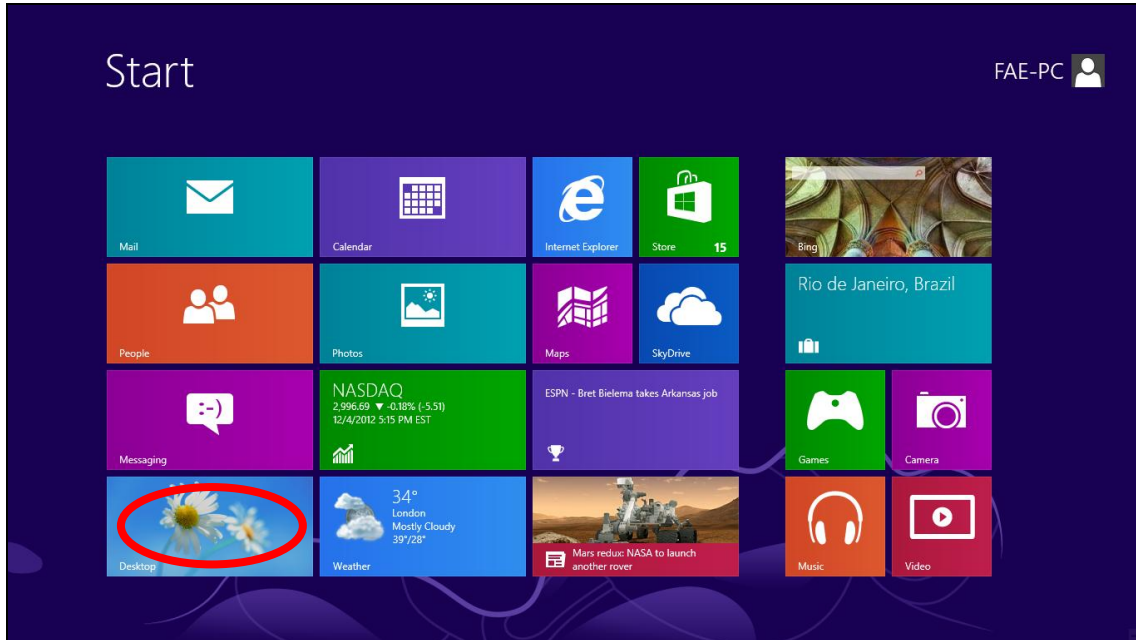

2. In desktop mode, click the File Explorer icon in the bottom left of the screen, as shown below.

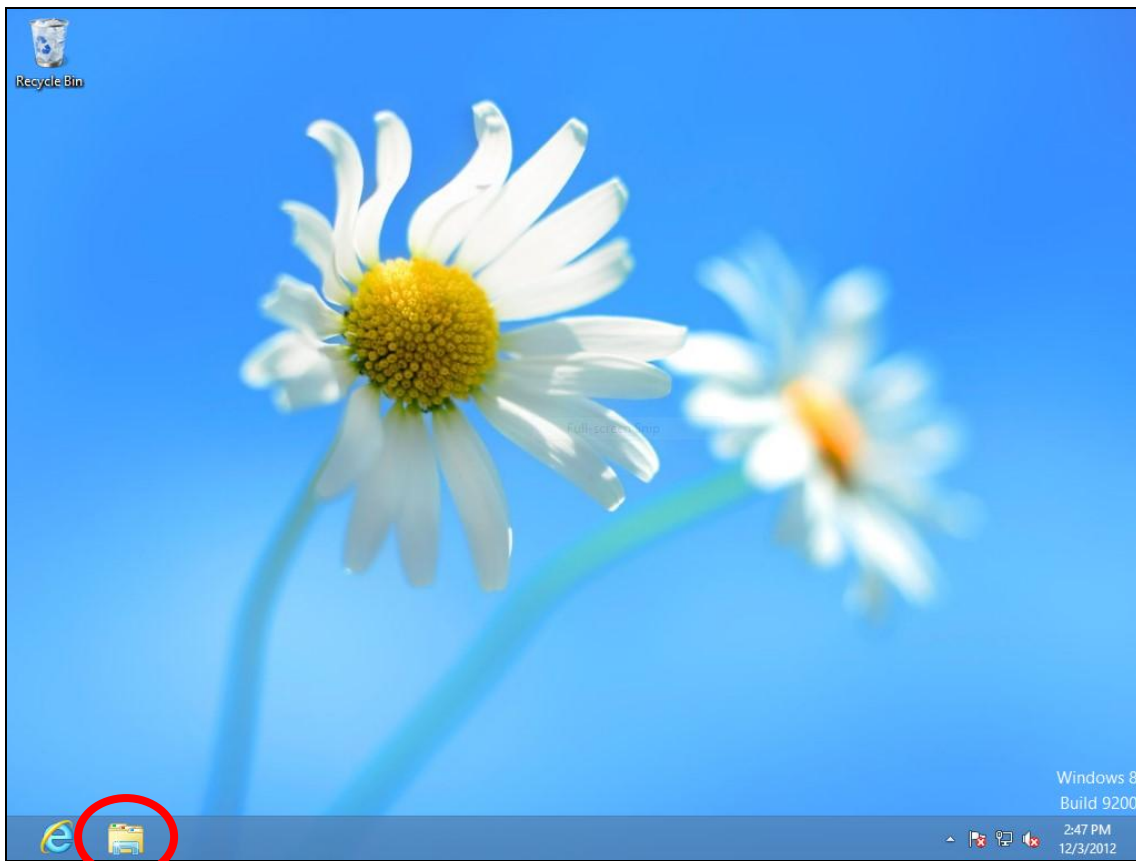

3. Right click “Network” and then select “Properties”.

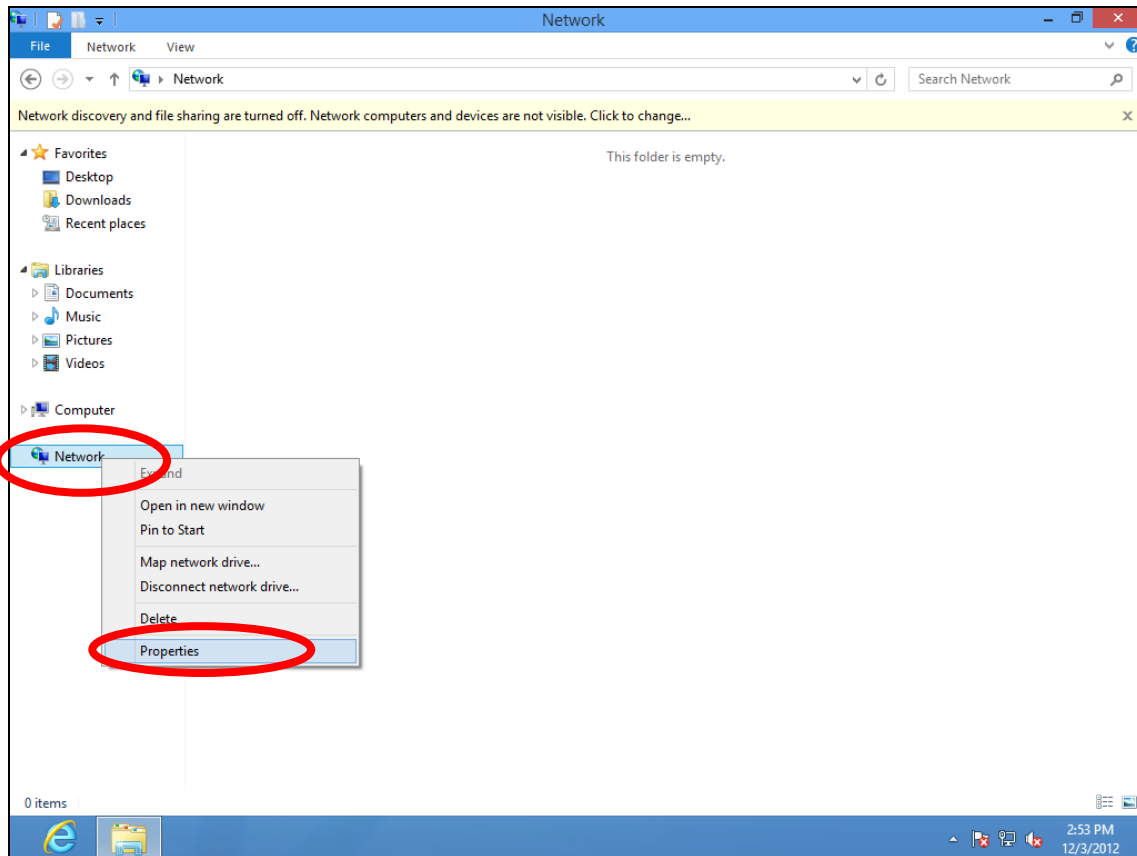

4. In the window that opens, select “Change adapter settings” from the left side.

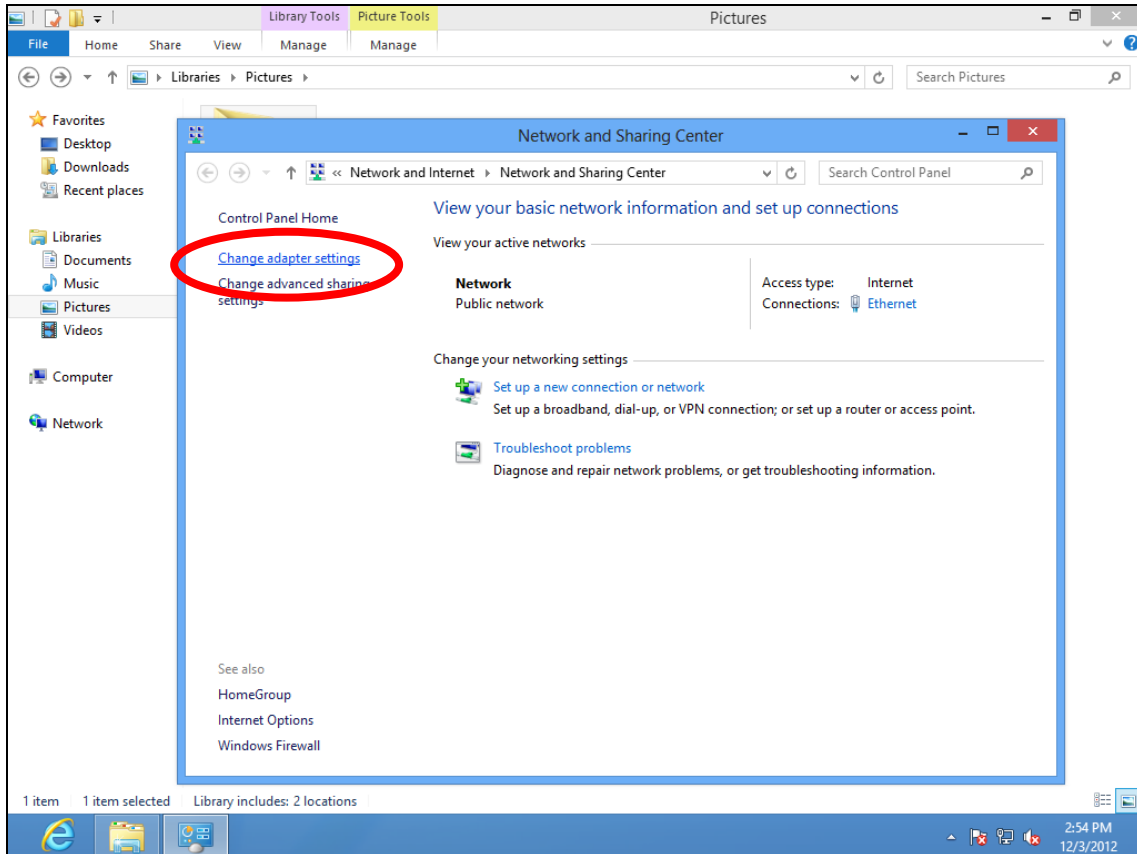

5. Choose your connection and right click, then select “Properties”.

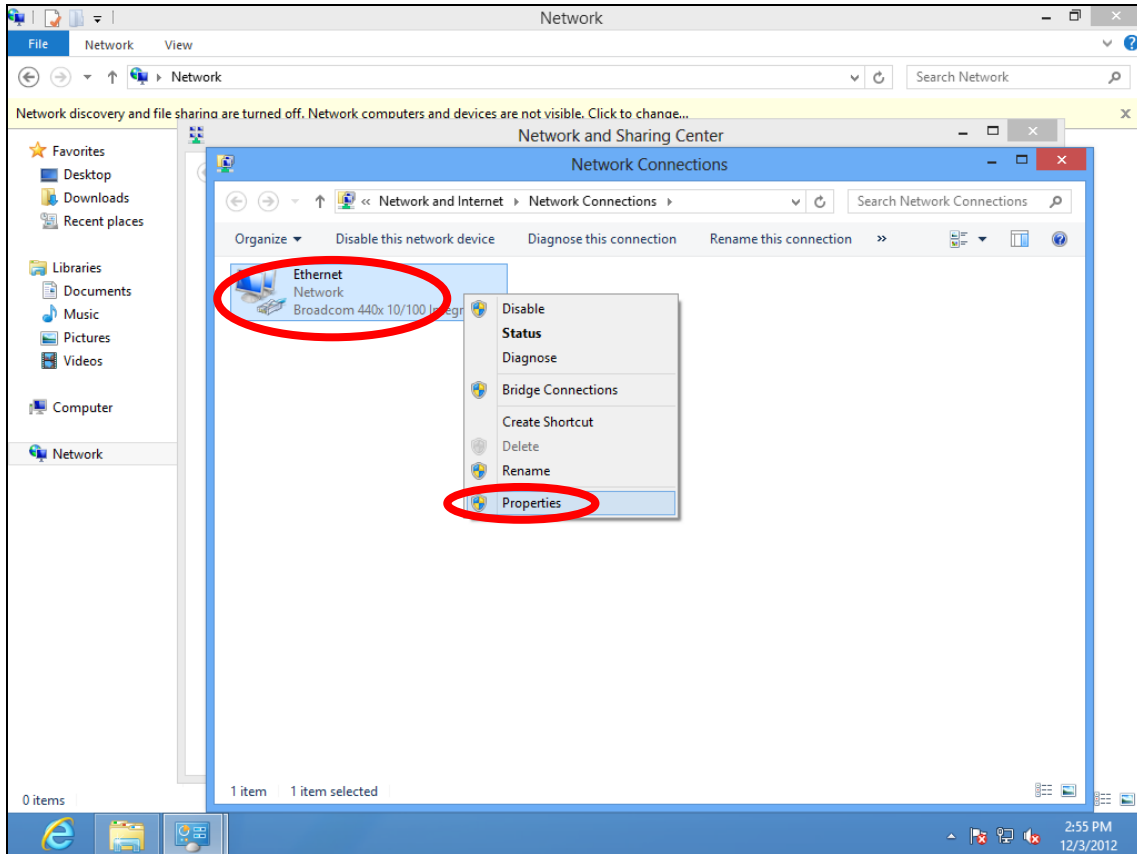

6. Select “Internet Protocol Version 4 (TCP/IPv4) and then click “Properties”.

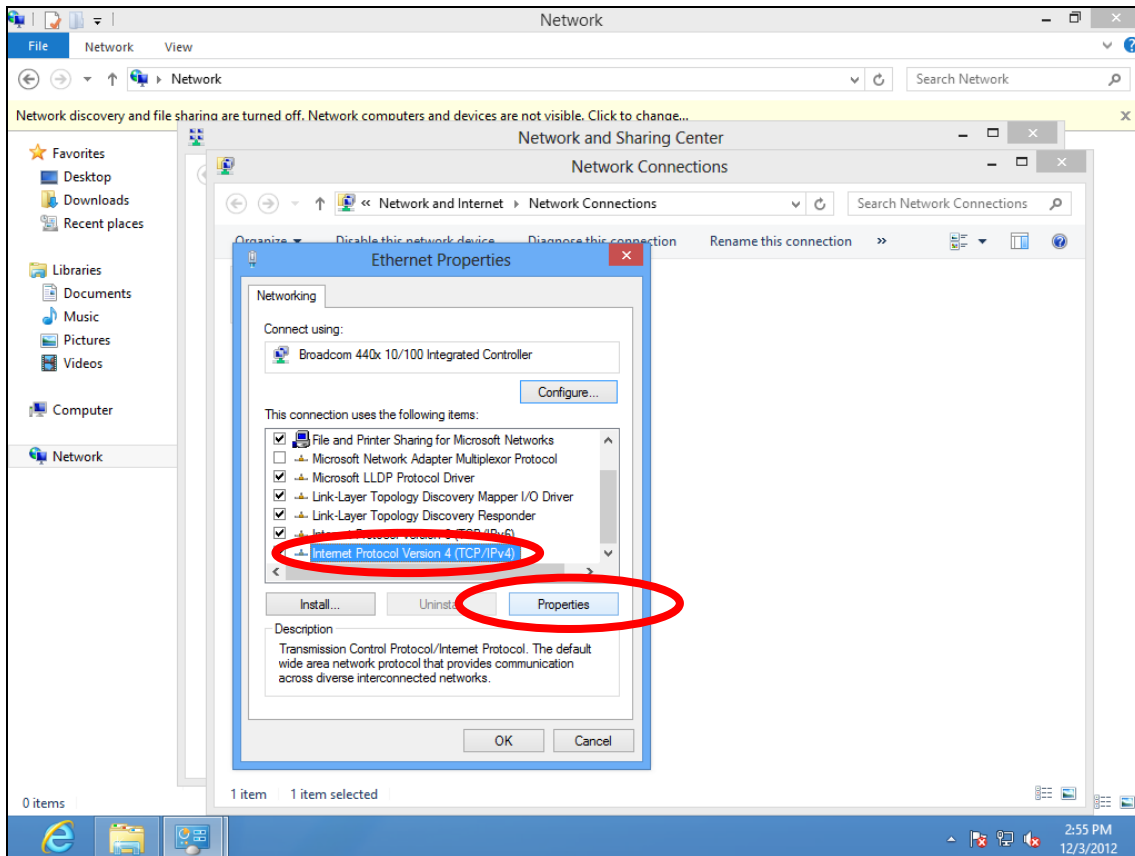

7. Select “Use the following IP address” and “Use the following DNS server addresses”, then input the following values:

 ***Your existing static IP address will be displayed in the “IP address” field before you replace it. Please make a note of this IP address, subnet mask, default gateway and DNS server addresses.***

IP address: 192.168.2.10

Subnet Mask: 255.255.255.0

Preferred DNS Server: 192.168.2.1

Click ‘OK’ when finished.

IV-1-2-5. Mac

1. Have your Macintosh computer operate as usual, and click on “System Preferences”

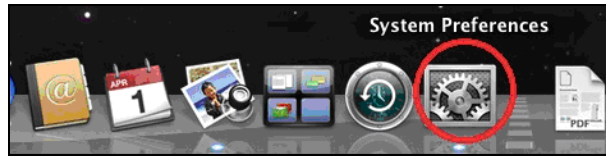

2. In System Preferences, click on “Network”.



3. Click on “Wi-Fi” in the left panel and then click “Advanced” in the lower right corner.

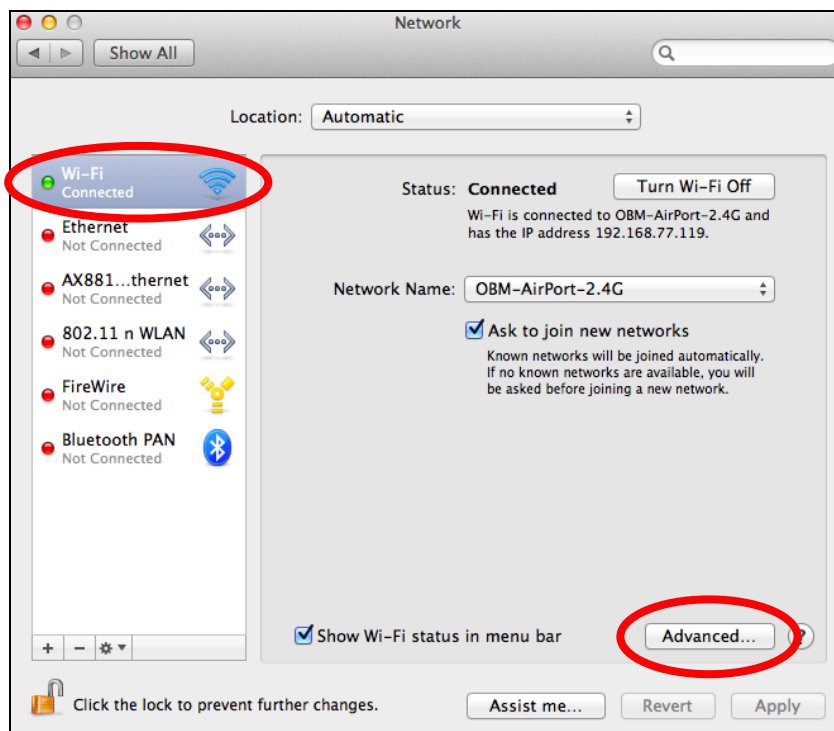

4. Select “TCP/IP” from the top menu and select “Manually” from the drop down menu labeled “Configure IPv4”, then click “OK”.

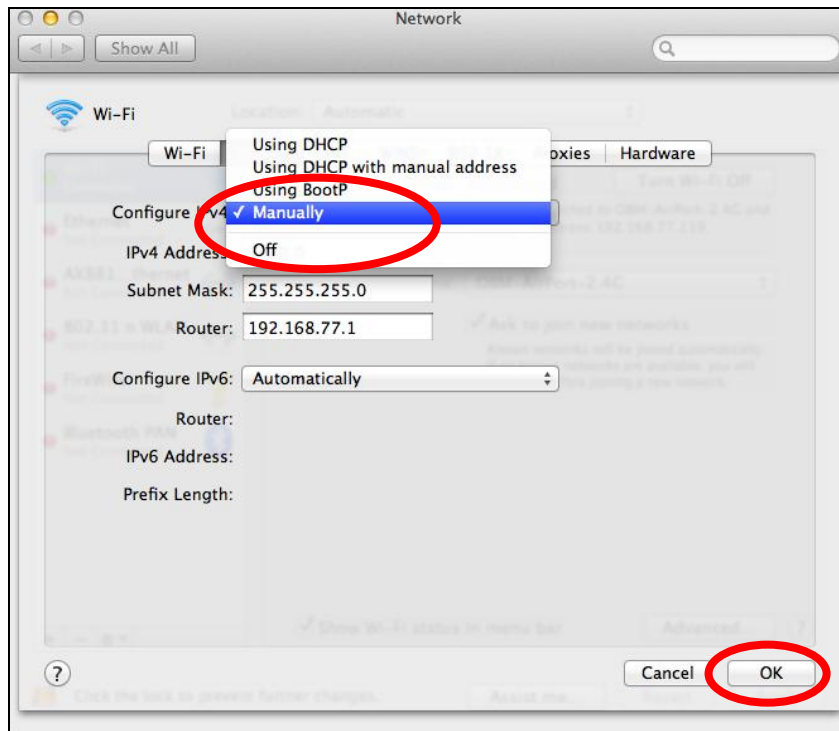

Your existing static IP address will be displayed in the “IP address” field before you replace it. Please make a note of this IP address, subnet mask, default gateway and DNS server addresses.

5. In the “IPv4 Address” and “Subnet Mask” field enter IP address 192.168.2.10 and subnet mask 255.255.255.0. Click on “OK”.

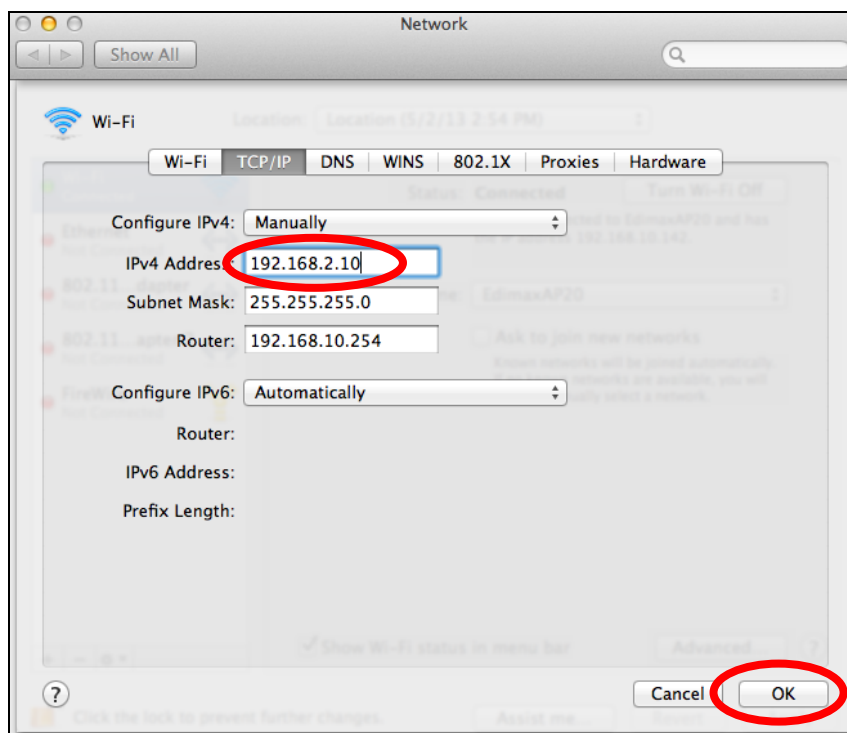

6. Click “Apply” to save the changes.

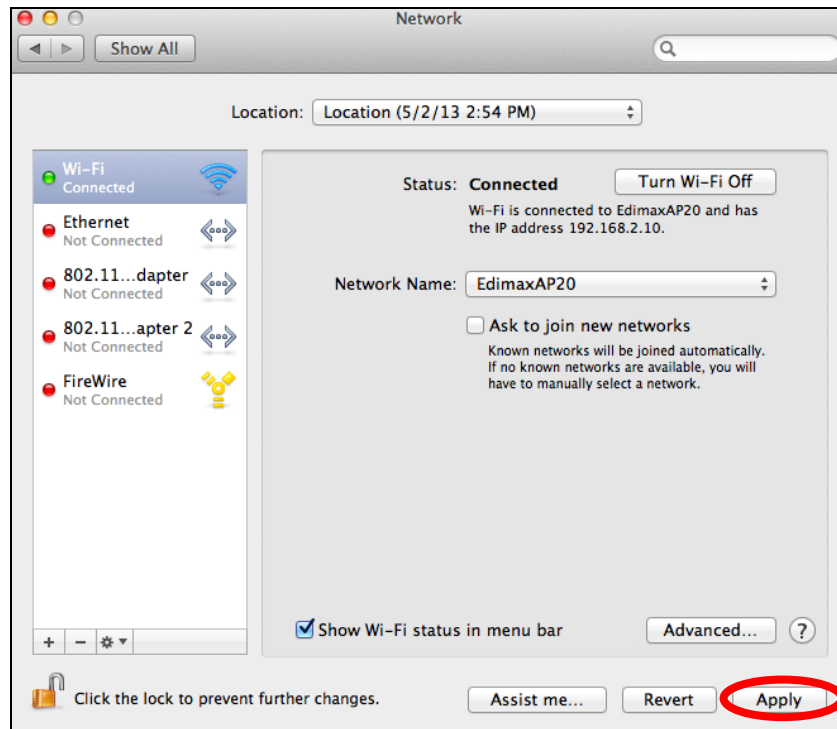

IV-1-3. How to Find Your Network Security Key

To find your network security key, please follow the instructions appropriate for your operating system.

 ***If you are using Windows XP or earlier, please contact your ISP or router manufacturer to find your network security key.***

IV-1-3-1. Windows 7 & Vista

1. Open “Control Panel” and click on “Network and Internet” in the top menu.

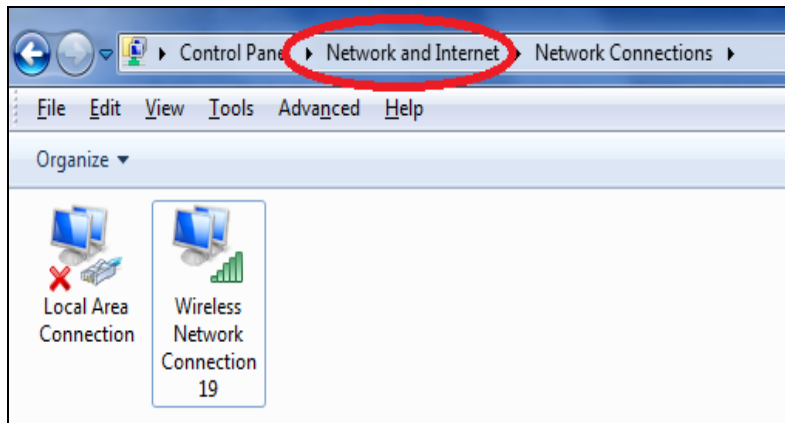

2. Click on “View network status and tasks” which is under the heading “Network and Sharing Center”.

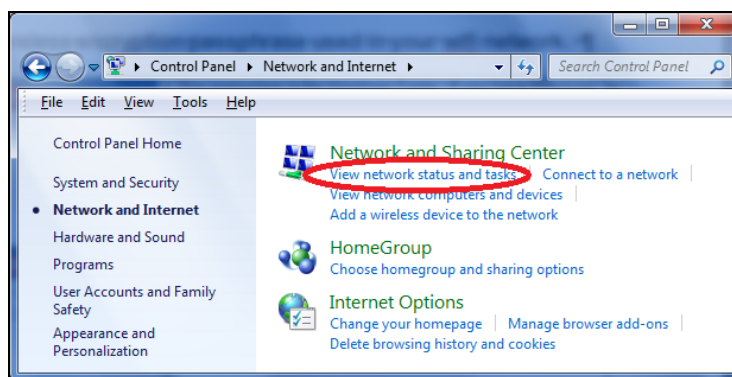

3. Click on “Manage wireless networks” in the left menu.

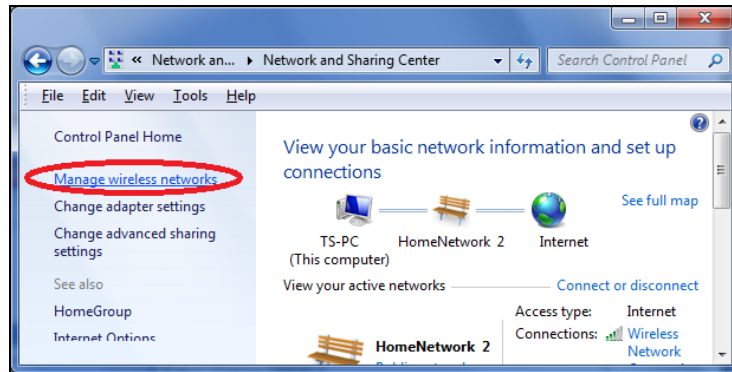

4. You should see the profile of your Wi-Fi network in the list. Right click on your Wi-Fi network and then click on “Properties”.

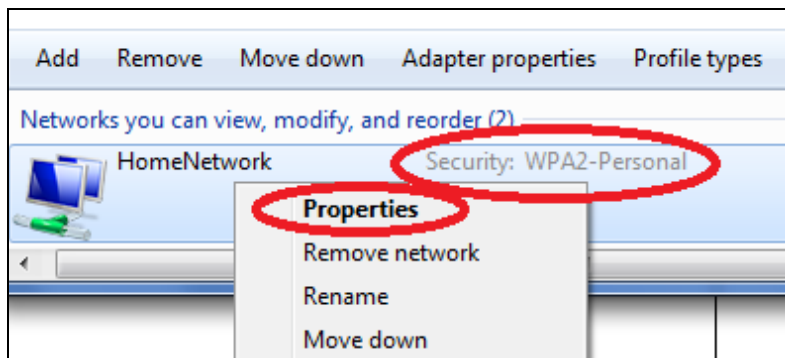

5. Click on the “Security” tab, and then check the box labeled “Show characters”. This will show your network security key. Click the “Cancel” button to close the window.

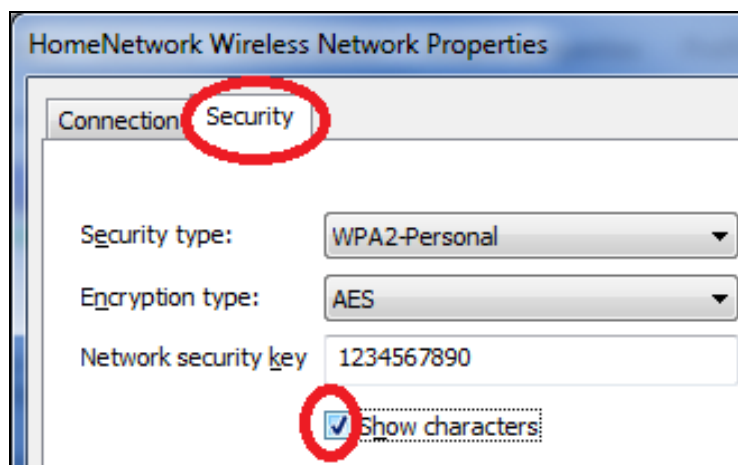

IV-1-3-2. Mac

1. Open a new Finder window, and select “Applications” from the menu on the left side. Open the folder labeled “Utilities” and then open the application “Keychain Access”.

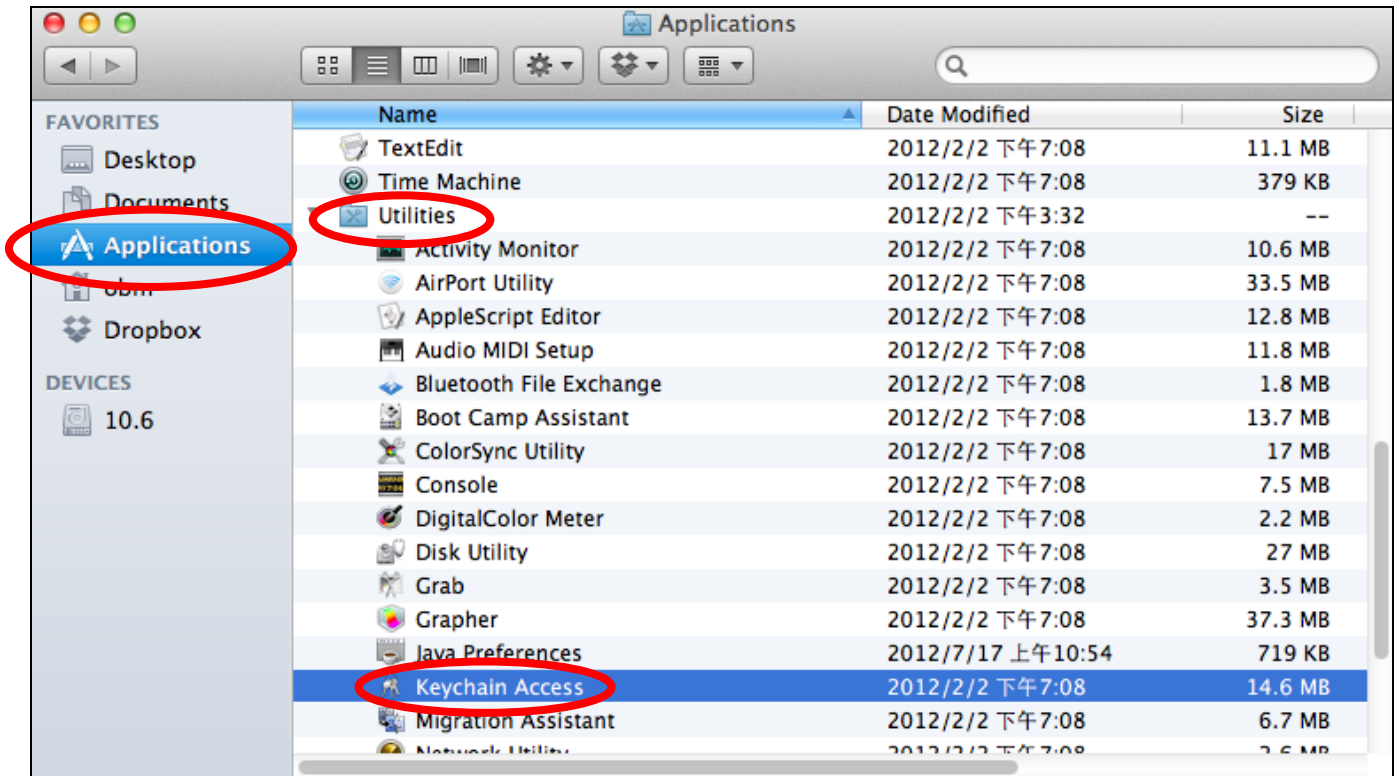

2. Select “Passwords” from the sub-menu labeled “Category” on the left side, as shown below. Then search the list in the main panel for the SSID of your network. In this example, the SSID is “EdimaxWireless” – though your SSID will be unique to your network.

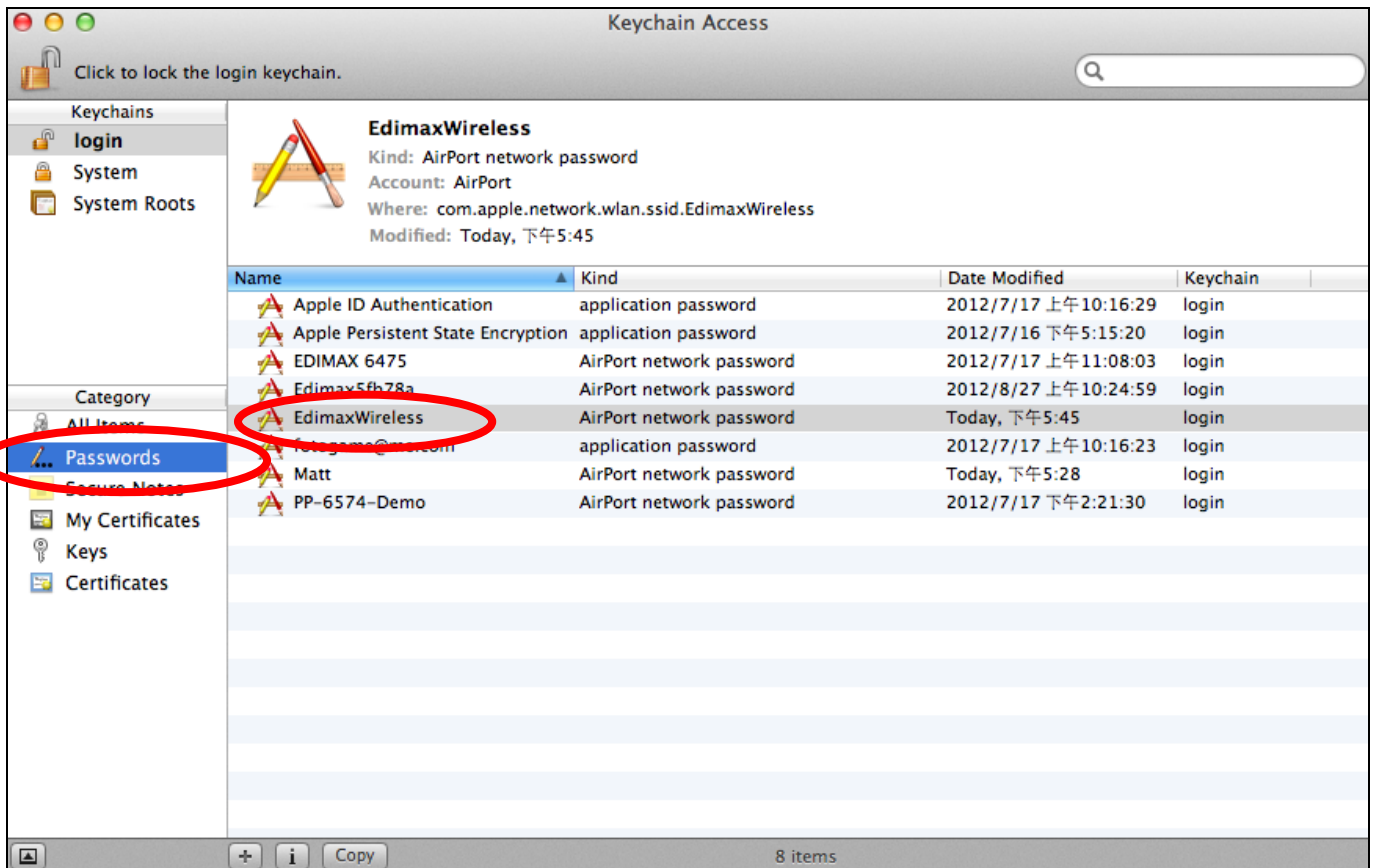

3. Double click the SSID of your network and you will see the following window.

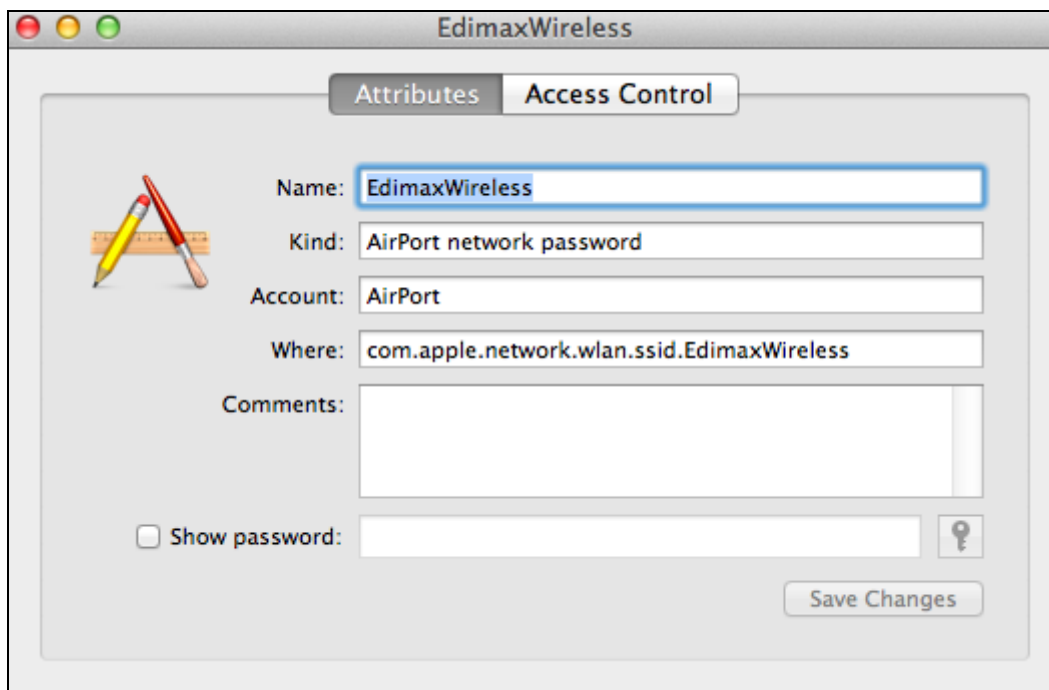

4. Check the box labeled "Show password" and you will be asked to enter your administrative password, which you use to log into your Mac. Enter your password and click "Allow".

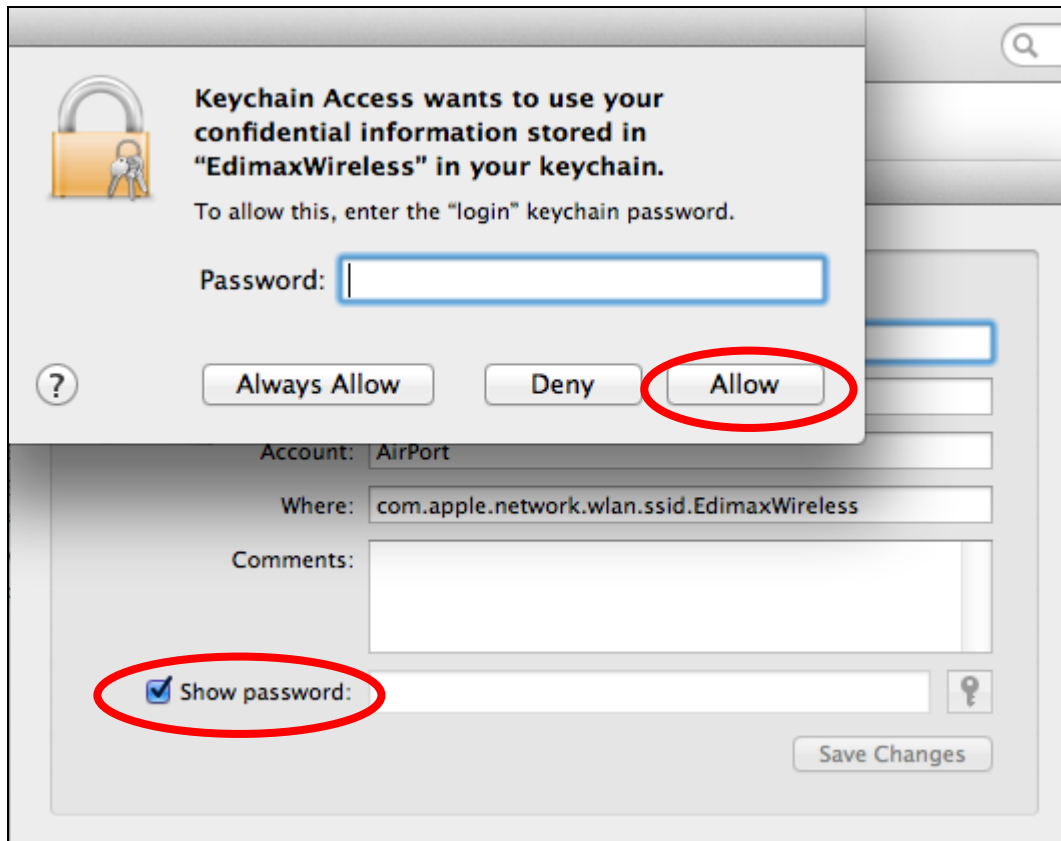

Your network security password will now be displayed in the field next to the box labeled "Show password". In the example below, the network security password is "edimax1234". Please make a note of your network security password.



IV-1-4. How to Find Your Router's IP Address

To find your router's IP address, please follow the instructions appropriate for your operating system.

IV-1-4-1. Windows XP, Vista & 7

1. Go to "Start", select "Run" and type "cmd", then press Enter or click "OK".

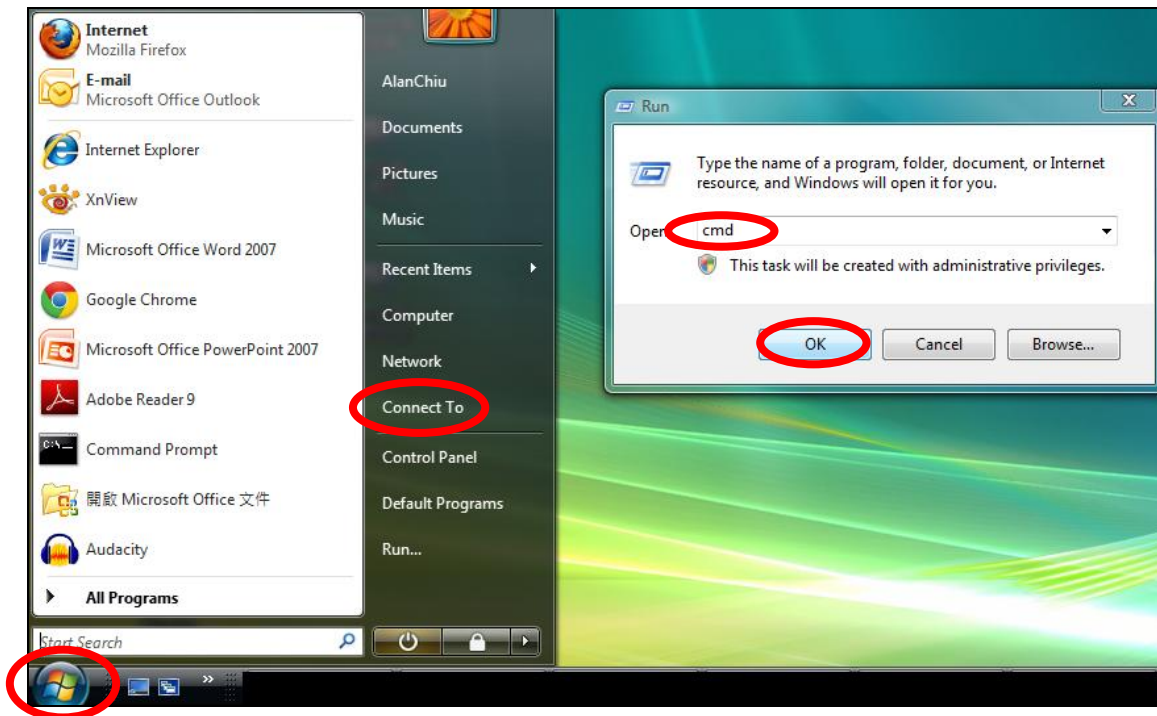

2. A new window will open, type "ipconfig" and press Enter.

```
Administrator: C:\Windows\system32\cmd.exe
Microsoft Windows [Version 6.0.6002]
Copyright (c) 2006 Microsoft Corporation. All rights reserved.

C:\Users\AlanChiu>ipconfig
```

3. Your router's IP address will be displayed next to "Default Gateway".

```
Administrator: C:\Windows\system32\cmd.exe
Ethernet adapter 區域連線:

    Connection-specific DNS Suffix . . . :
    Link-local IPv6 Address . . . . . : fe80::4cdc:3e90:ba56:1722%9
    IPv4 Address. . . . . : 192.168.10.14
    Subnet Mask . . . . . : 255.255.255.0
    Default Gateway . . . . . : fe80::1867:2a1b:e9c2:e57b%9
                                192.168.10.254

Wireless LAN adapter 無線網路連線:

    Media State . . . . . : Media disconnected
    Connection-specific DNS Suffix . . : edimax.com

Tunnel adapter 區域連線* 6:

    Media State . . . . . : Media disconnected
    Connection-specific DNS Suffix . . :

Tunnel adapter 區域連線* 7:

    Media State . . . . . : Media disconnected
    Connection-specific DNS Suffix . . :

C:\Users\AlanChiu>
```

IV-1-4-2. Windows 8

1. From the Windows 8 Start screen, move your cursor to the top right corner of the screen to display the Charms bar.

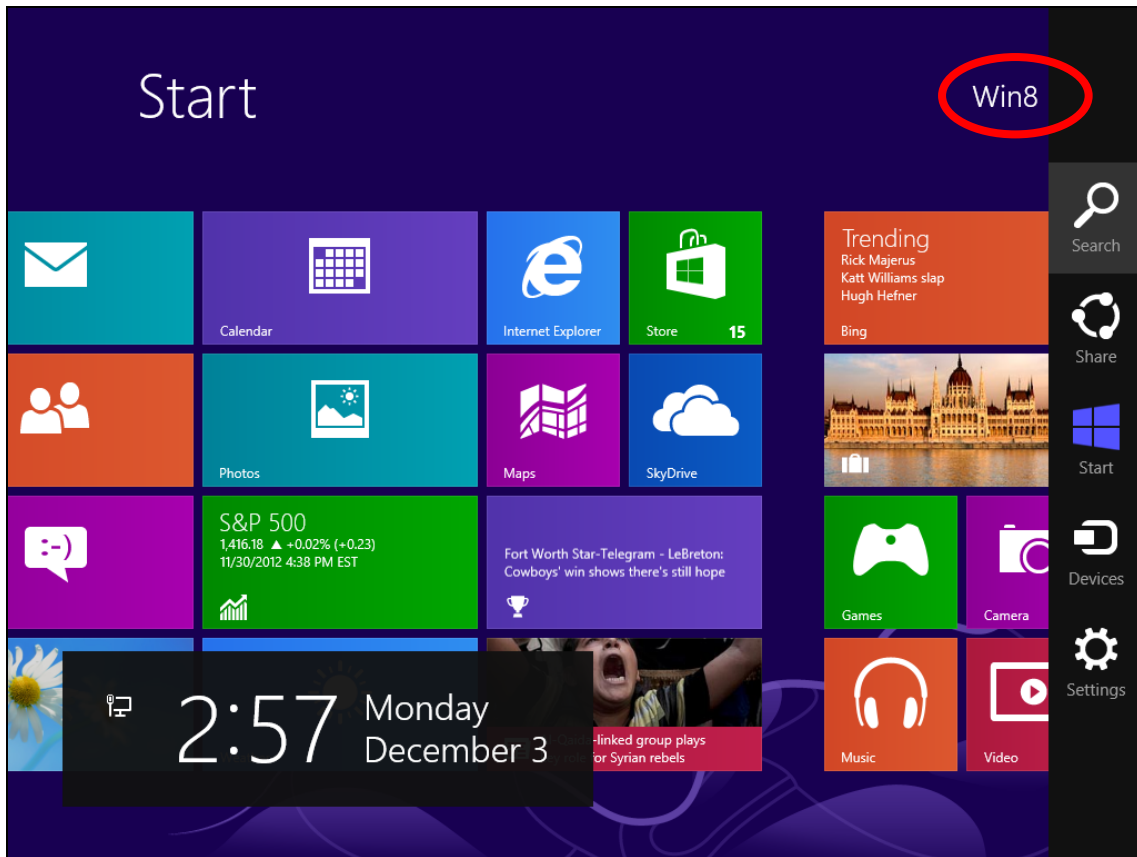

2. Click "Search" and enter "cmd" into the search bar. Click the "Command Prompt" app which be displayed on the left side.

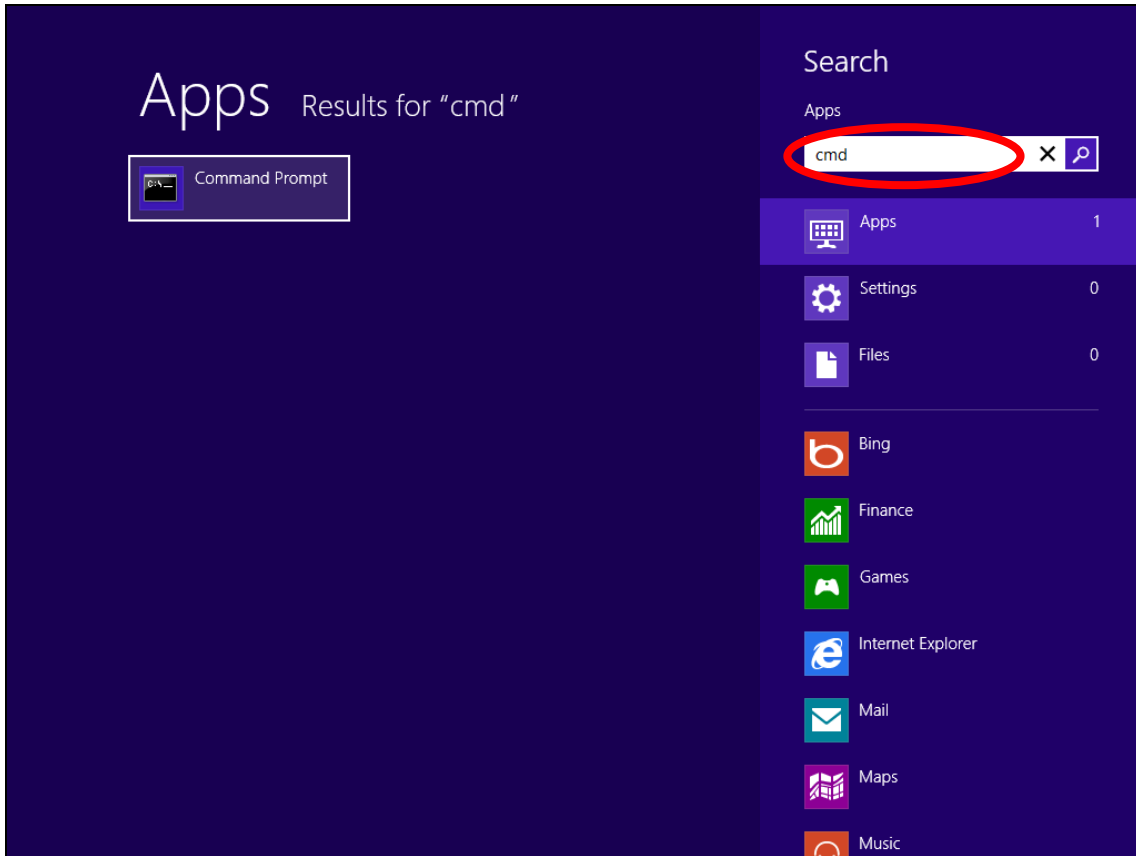

3. A new window will open, type “ipconfig” and press Enter.

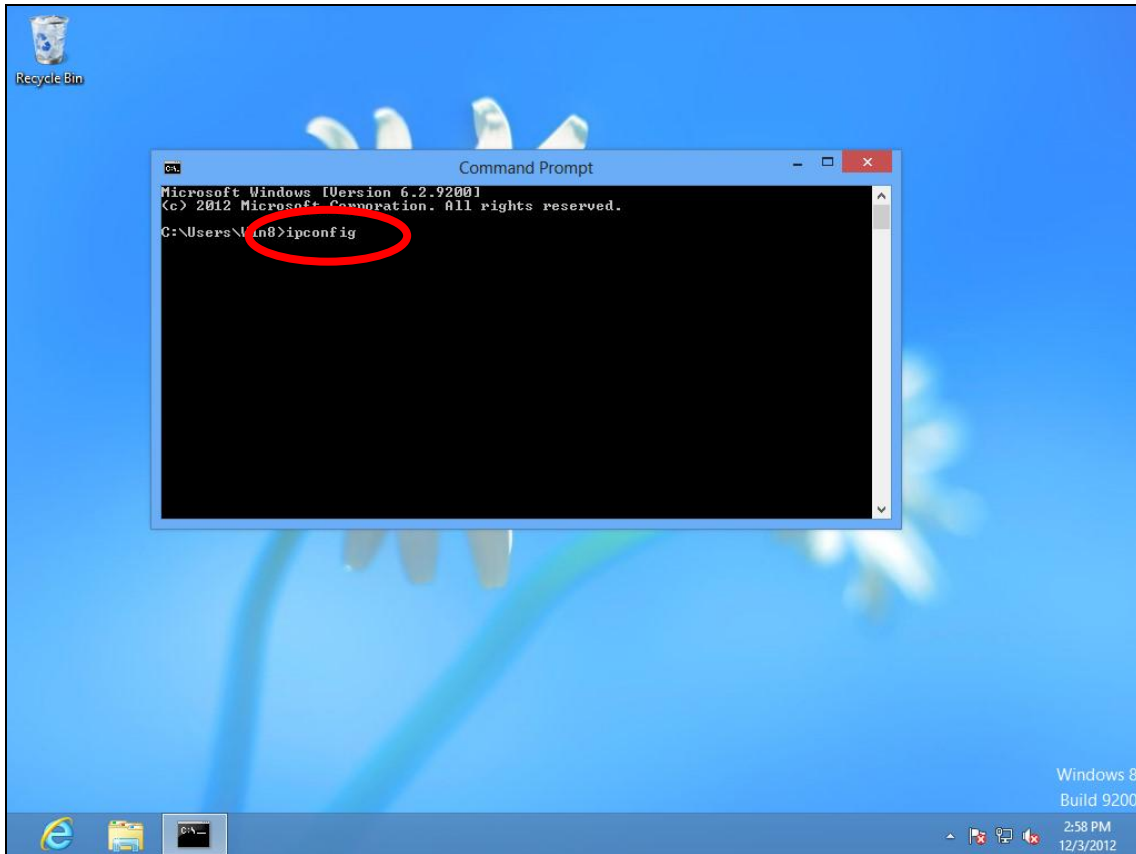

4. Your router's IP address will be displayed next to "Default Gateway".

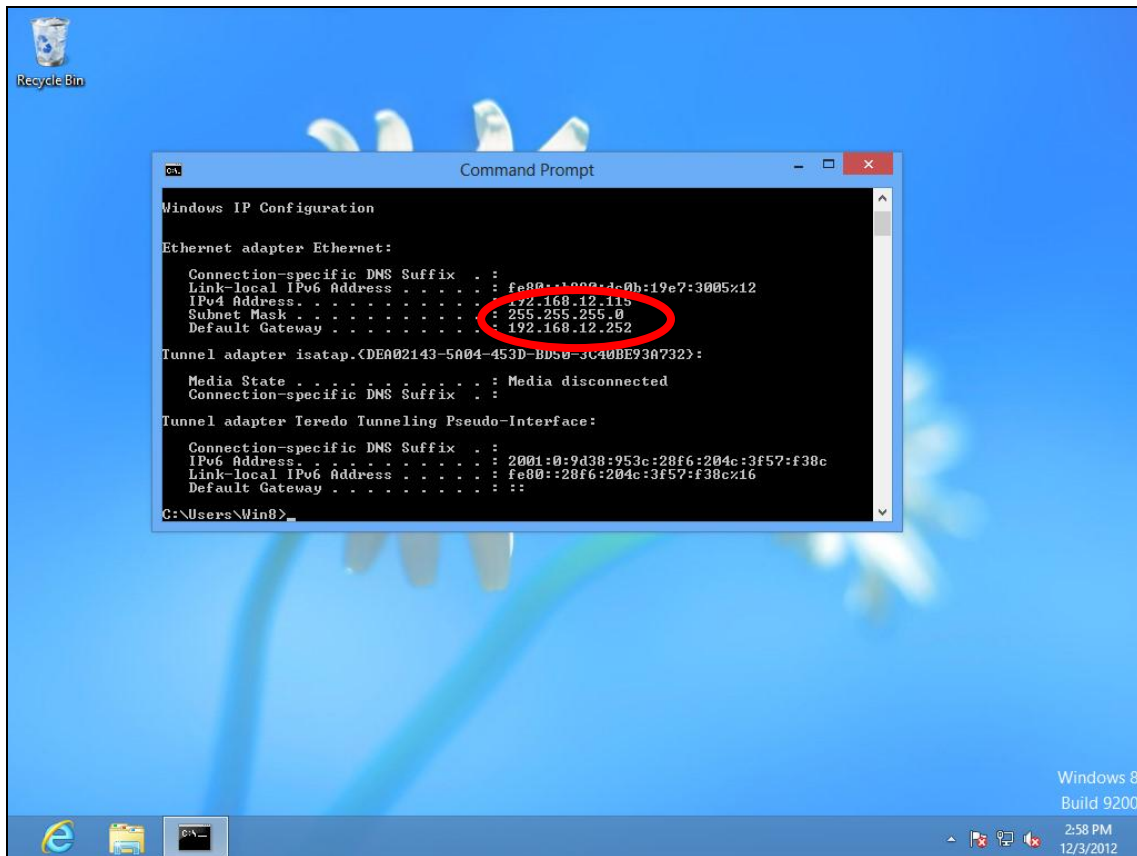

IV-1-4-3. Mac

1. Launch “System Preferences” and click on “Network”.
2. If you are using an Ethernet cable to connect to your network, your router’s IP address will be displayed next to “Router”.

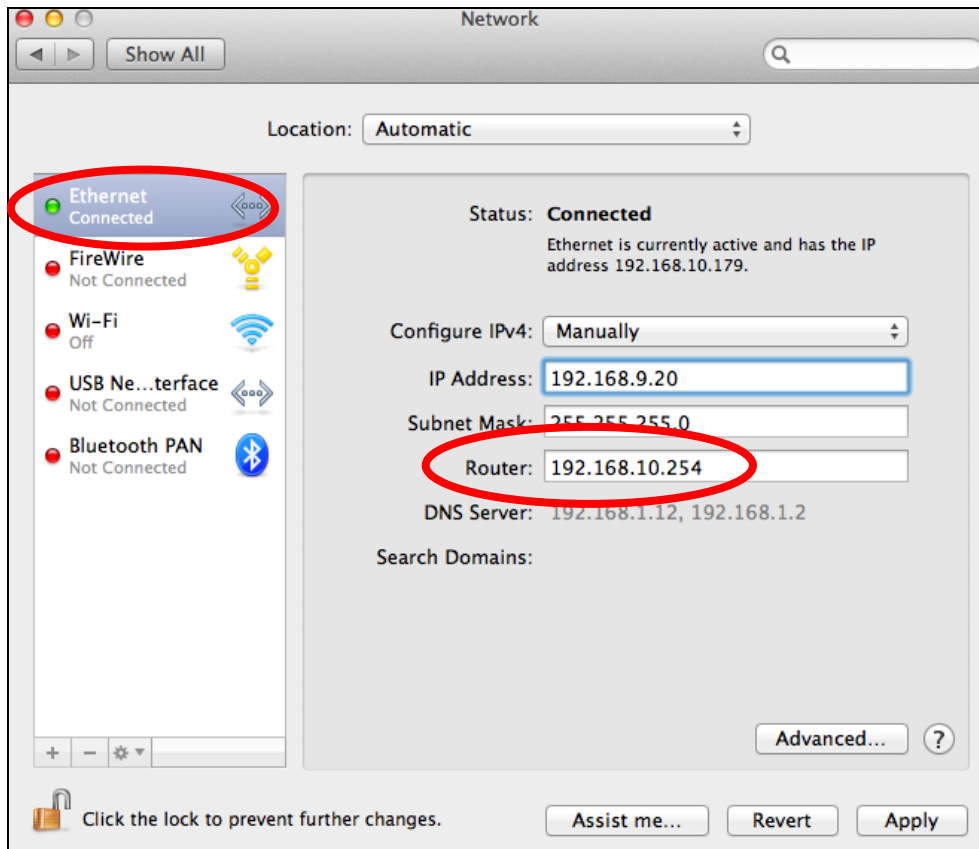

3. If you are using Wi-Fi, click “Wi-Fi” in the left panel, and then “Advanced” in the bottom right corner.

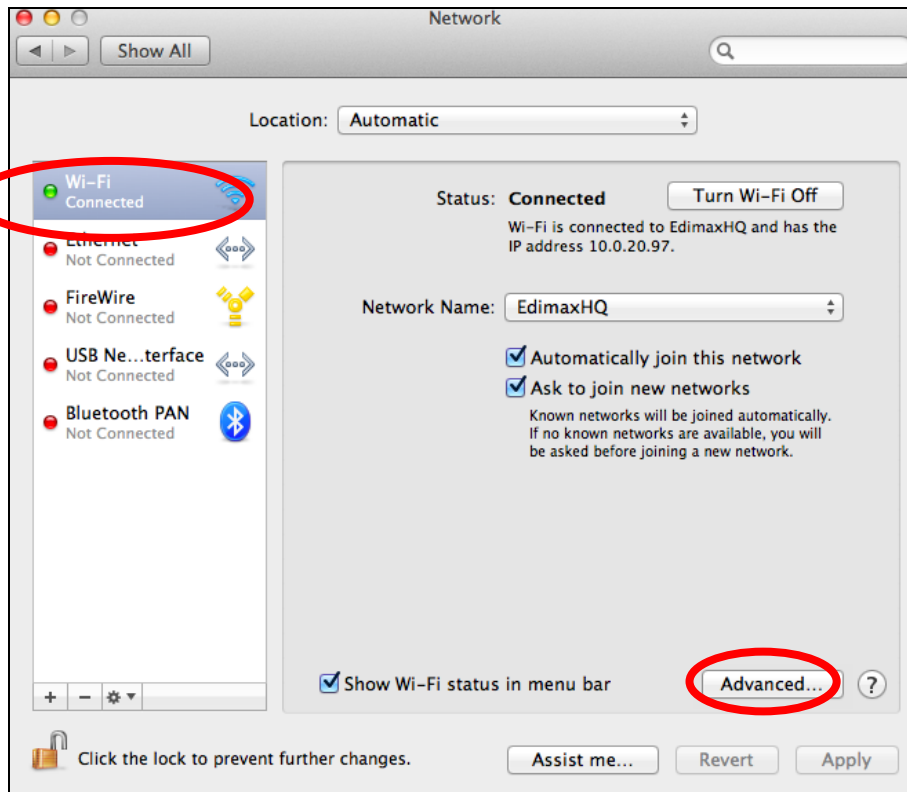



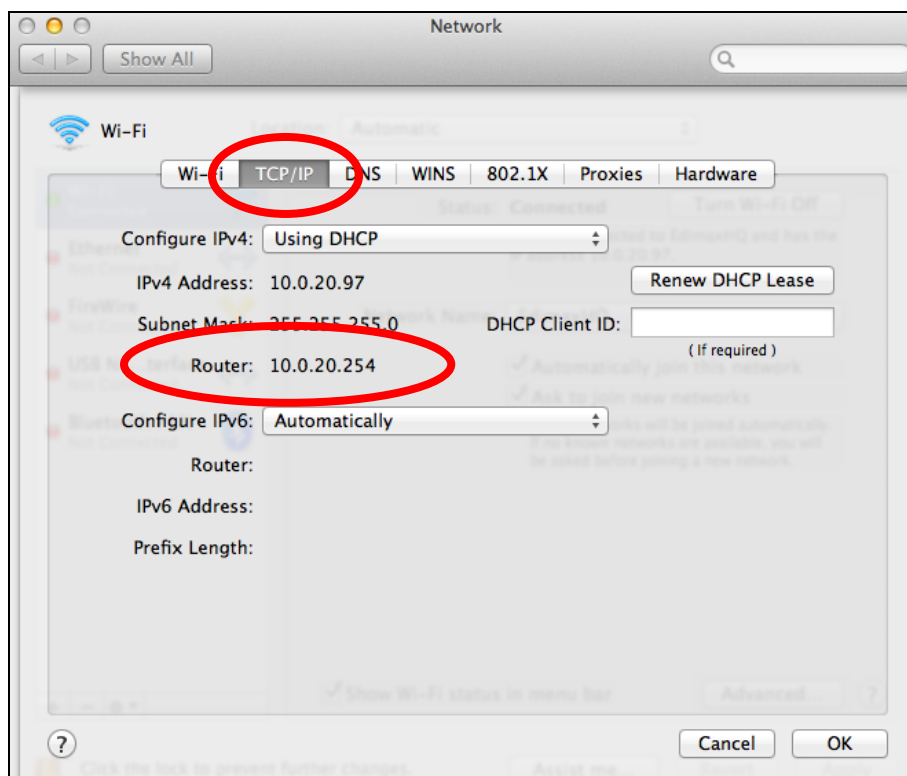

4. Click the “TCP/IP” tab and your router’s IP address will be displayed next to “Router”.



IV-2. Connecting to a Wi-Fi network

For help connecting to your device's **Edimax.Setup** SSID for initial setup, or to connect to your device's new Wi-Fi network (SSID) after setup is complete, follow the guide below:

 ***Below is an example of how to connect using Windows Vista – the process may vary slightly for other versions of Windows.***

1. Click the network icon (, , or ) in the system tray and select “Connect to a network”.

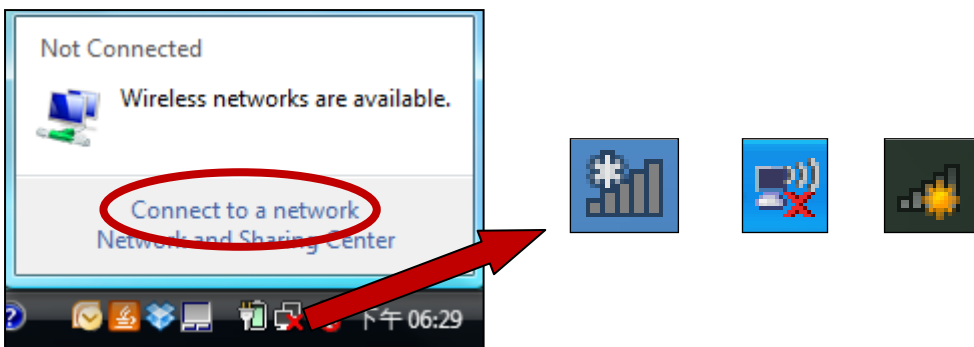

2. Search for the SSID of your BR-6478 AC V2 and then click “Connect”. If you set a password for your network, you will then be prompted to enter it.

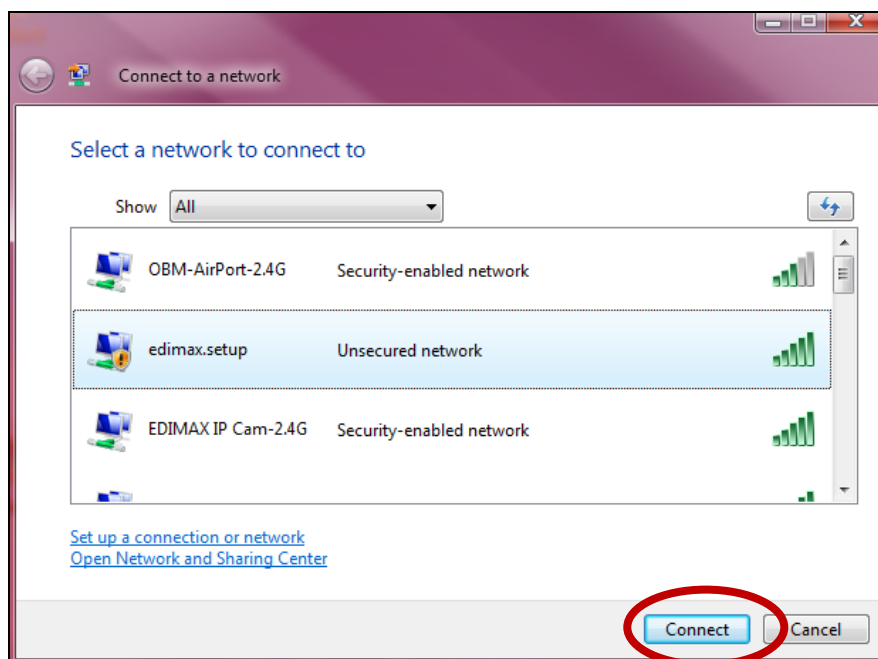

3. After correctly entering your password, you will be successfully connected to the BR-6478 AC V2's wireless network.

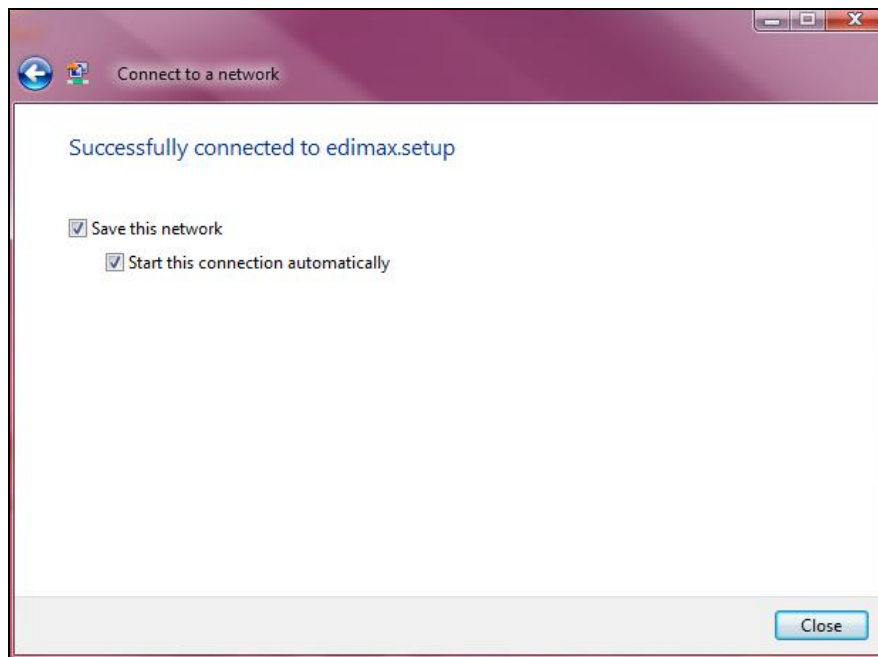

IV-3. FAQs

1. How do I use USB storage?

- a. Connect your USB storage to the USB port on the rear of the BR-6478AC V2. USB sharing is enabled by default so devices on your network can access the USB storage drive using appropriate tools for your OS (e.g. Windows File Explorer → Network).



USB drives should be pre-formatted to support FAT32 or NTFS file systems before using with the USB port. USB hubs are not supported.

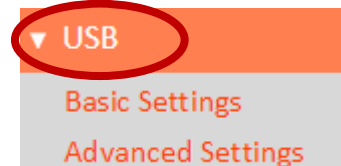

For more detailed configurations such as folder-sharing and FTP, login to the browser-based configuration interface at <http://edimax.setup> and go to USB in the main menu.

2. How do I share a printer?

- a. Go to **USB → Basic Settings** at <http://edimax.setup> and **enable** USB Sharing and select **Print Server**.

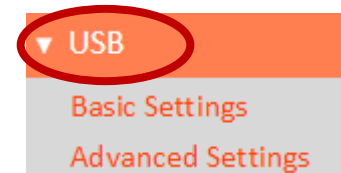

Connect your printer to the device with a USB cable and ensure printer drivers are installed on computers that you wish to share the printer with. Then install the Edimax Device Server Utility from the included CD (the utility can also be downloaded from **USB → Basic Settings**).

3. How do I setup a VPN server?

- a. A VPN server can be used for remote access to your network as well as for additional security & privacy. Login to <http://edimax.setup> and go to **Internet → VPN** to setup the server. A VPN client such as OpenVPN is required on your network device to access the VPN remotely.



4. I can't access the Internet.

- Ensure that all cables are connected properly. Try a different Ethernet cable.
- Check if you can access the web based configuration interface. If not, please ensure your computer is set to use a dynamic IP address.
- Login to the web based configuration interface and go to **Internet > WAN Setup** and check that the connection type is correct. If you are unsure which internet connection type you have, please contact your Internet Service Provider (ISP).
- Connect your computer directly to your modem and check if you can access the internet. If you can't, please contact your Internet service provider for assistance.

5. I can't open the web based configuration interface.

- Please ensure your computer is set to use a dynamic IP address.

6. How do I reset my device to factory default settings?

- To reset the device back to its factory default settings, press and hold the WPS/Reset button for over 10 seconds, until the Internet LED begins to flash. Please wait a few minutes for the product to restart. When the device restarts, all settings will be reset. Default settings are displayed on the product label on the back of the device, as shown below:



Router Login	Enter this URL in a web browser to run iQ Setup or configure advanced settings. You must be
---------------------	---

	connected to the device by Wi-Fi or Ethernet cable.
Username/Password	This is the default username and password to access the browser based configuration interface when you go to the “Router Login” URL (above).
Wi-Fi Network Name	This is the default Wi-Fi network name for the device. Search for this name (SSID) and connect to it in order to access the “Router Login” URL (above).
MAC	A MAC address is unique to every device and is used for identification within a network. Your device’s unique MAC addresses are displayed here.
PIN CODE	This is your device’s PIN code for Wi-Fi Protected Setup (WPS) for each wireless frequency.

7. I forgot my password.

- a. Reset the router to its factory default settings and use the default username **admin** and default password **1234**. Default settings are displayed on the product label on the back of the device, as shown above.

8. Do the blue WAN port and yellow LAN ports work the same when the device is in different modes?

No, the WAN and LAN ports have slightly different functions depending on the operating mode of the device.

- a. In **Wi-Fi router** mode, the **WAN port** is for a direct connection to your xDSL modem. The **LAN ports** are for wired network clients.
- b. In **access point** mode, the **WAN port** is not functional. Connect your existing router to the device’s **LAN port**, and the other **LAN ports** can connect wired network clients.
- c. In **Wi-Fi extender, Wi-Fi bridge & WISP** mode, the **WAN port** is not functional and the **LAN ports** are for wired network clients. Do not connect your existing router to the device’s **WAN** or **LAN ports**, as this can cause the device to malfunction.

V. Glossary

Default Gateway (Wireless bridge): Every non-access point IP device needs to configure a default gateway's IP address. When the device sends out an IP packet, if the destination is not on the same network, the device has to send the packet to its default gateway, which will then send it out towards the destination.

DHCP: Dynamic Host Configuration Protocol. This protocol automatically gives every computer on your home network an IP address.

DNS Server IP Address: DNS stands for Domain Name System, which allows Internet servers to have a domain name (such as `www.Broadbandaccesspoint.com`) and one or more IP addresses (such as `74.125.128.104`). A DNS server keeps a database of Internet servers and their respective domain names and IP addresses, so that when a domain name is requested (as in typing "`Broadbandaccesspoint.com`" into your Internet browser), the user is sent to the proper IP address. The DNS server IP address used by the computers on your home network is the location of the DNS server your ISP has assigned to you.

DSL Modem: DSL stands for Digital Subscriber Line. A DSL modem uses your existing phone lines to transmit data at high speeds.

Ethernet: A standard for computer networks. Ethernet networks are connected by special cables and hubs, and move data around at up to 10/100 million bits per second (Mbps).

IP Address and Network (Subnet) Mask: IP stands for Internet Protocol. An IP address consists of a series of four numbers separated by periods, that identifies a single, unique Internet computer host in an IP network. Example: `192.168.2.1`. It consists of 2 portions: the IP network address, and the host identifier.

The IP address is a 32-bit binary pattern, which can be represented as four cascaded decimal numbers separated by ".": `aaa.aaa.aaa.aaa`, where each "aaa" can be anything from 000 to 255, or as four cascaded binary numbers separated by ".": `bbbbbbbb.bbbbbbbb.bbbbbbbb.bbbbbbbb`, where each "b" can either be 0 or 1.

A network mask is also a 32-bit binary pattern, and consists of consecutive leading 1's followed by consecutive trailing 0's, such as 11111111.11111111.11111111.00000000. Therefore sometimes a network mask can also be described simply as "x" number of leading 1's. When both are represented side by side in their binary forms, all bits in the IP address that correspond to 1's in the network mask become part of the IP network address, and the remaining bits correspond to the host ID.

For example, if the IP address for a device is, in its binary form, 11011001.10110000.10010000.00000111, and if its network mask is, 11111111.11111111.11110000.00000000

It means the device's network address is 11011001.10110000.10010000.00000000, and its host ID is, 00000000.00000000.00000000.00000111. This is a convenient and efficient method for access points to route IP packets to their destination.

ISP Gateway Address: (see ISP for definition). The ISP Gateway Address is an IP address for the Internet access point located at the ISP's office.

ISP: Internet Service Provider. An ISP is a business that provides connectivity to the Internet for individuals and other businesses or organizations.

LAN: Local Area Network. A LAN is a group of computers and devices connected together in a relatively small area (such as a house or an office). Your home network is considered a LAN.

MAC Address: MAC stands for Media Access Control. A MAC address is the hardware address of a device connected to a network. The MAC address is a unique identifier for a device with an Ethernet interface. It is comprised of two parts: 3 bytes of data that corresponds to the Manufacturer ID (unique for each manufacturer), plus 3 bytes that are often used as the product's serial number.

NAT: Network Address Translation. This process allows all of the computers on your home network to use one IP address. Using the broadband access point's NAT capability, you can access the Internet from any computer on your home network without having to purchase more IP addresses from your ISP.

Port: Network Clients (LAN PC) uses port numbers to distinguish one network application/protocol over another. Below is a list of common applications and protocol/port numbers:

Application	Protocol	Port Number
Telnet	TCP	23
FTP	TCP	21
SMTP	TCP	25
POP3	TCP	110
H.323	TCP	1720
SNMP	UCP	161
SNMP Trap	UDP	162
HTTP	TCP	80
PPTP	TCP	1723
PC Anywhere	TCP	5631
PC Anywhere	UDP	5632

Access point: A access point is an intelligent network device that forwards packets between different networks based on network layer address information such as IP addresses.

Subnet Mask: A subnet mask, which may be a part of the TCP/IP information provided by your ISP, is a set of four numbers (e.g. 255.255.255.0) configured like an IP address. It is used to create IP address numbers used only within a particular network (as opposed to valid IP address numbers recognized by the Internet, which must be assigned by InterNIC).

TCP/IP, UDP: Transmission Control Protocol/Internet Protocol (TCP/IP) and User Datagram Protocol (UDP). TCP/IP is the standard protocol for data transmission over the Internet. Both TCP and UDP are transport layer protocol. TCP performs proper error detection and error recovery, and thus is reliable. UDP on the other hand is not reliable. They both run on top of the IP (Internet Protocol), a network layer protocol.

WAN: Wide Area Network. A network that connects computers located in geographically separate areas (e.g. different buildings, cities, countries). The Internet is a wide area network.

Web-based management Graphical User Interface (GUI): Many devices support a graphical user interface that is based on the web browser. This means the user can use the familiar Netscape or Microsoft Internet Explorer to Control/configure or monitor the device being managed.

COPYRIGHT

Copyright © Edimax Technology Co., Ltd. all rights reserved. No part of this publication may be reproduced, transmitted, transcribed, stored in a retrieval system, or translated into any language or computer language, in any form or by any means, electronic, mechanical, magnetic, optical, chemical, manual or otherwise, without the prior written permission from Edimax Technology Co., Ltd.

Edimax Technology Co., Ltd. makes no representations or warranties, either expressed or implied, with respect to the contents hereof and specifically disclaims any warranties, merchantability, or fitness for any particular purpose. Any software described in this manual is sold or licensed as is. Should the programs prove defective following their purchase, the buyer (and not this company, its distributor, or its dealer) assumes the entire cost of all necessary servicing, repair, and any incidental or consequential damages resulting from any defect in the software. Edimax Technology Co., Ltd. reserves the right to revise this publication and to make changes from time to time in the contents hereof without the obligation to notify any person of such revision or changes.

The product you have purchased and the setup screen may appear slightly different from those shown in this QIG. The software and specifications are subject to change without notice. Please visit our website www.edimax.com for updates. All brand and product names mentioned in this manual are trademarks and/or registered trademarks of their respective holders.

Federal Communication Commission Interference Statement

This equipment has been tested and found to comply with the limits for a Class B digital device, pursuant to Part 15 of FCC Rules. These limits are designed to provide reasonable protection against harmful interference in a residential installation. This equipment generates, uses, and can radiate radio frequency energy and, if not installed and used in accordance with the instructions, may cause harmful interference to radio communications. However, there is no guarantee that interference will not occur in a particular installation. If this equipment does cause harmful interference to radio or television reception, which can be determined by turning the equipment off and on, the user is encouraged to try to correct the interference by one or more of the following measures:

1. Reorient or relocate the receiving antenna.
2. Increase the separation between the equipment and receiver.
3. Connect the equipment into an outlet on a circuit different from that to which the receiver is connected.
4. Consult the dealer or an experienced radio technician for help.

FCC Caution

This device and its antenna must not be co-located or operating in conjunction with any other antenna or transmitter. This device complies with Part 15 of the FCC Rules. Operation is subject to the following two conditions: (1) this device may not cause harmful interference, and (2) this device must accept any interference received, including interference that may cause undesired operation. Any changes or modifications not expressly approved by the party responsible for compliance could void the authority to operate equipment.

Federal Communications Commission (FCC) Radiation Exposure Statement

This equipment complies with FCC radiation exposure set forth for an uncontrolled environment. In order to avoid the possibility of exceeding the FCC radio frequency exposure limits, human proximity to the antenna shall not be less than 2.5cm (1 inch) during normal operation.

Federal Communications Commission (FCC) RF Exposure Requirements

This EUT is compliance with SAR for general population/uncontrolled exposure limits in ANSI/IEEE C95.1-1999 and had been tested in accordance with the measurement methods and procedures specified in OET Bulletin 65 Supplement C. The equipment version marketed in US is restricted to usage of the channels 1-11 only. This equipment is restricted to *indoor* use when operated in the 5.15 to 5.25 GHz frequency range.

R&TTE Compliance Statement

This equipment complies with all the requirements of DIRECTIVE 1999/5/EC OF THE EUROPEAN PARLIAMENT AND THE COUNCIL of March 9, 1999 on radio equipment and telecommunication terminal equipment and the mutual recognition of their conformity (R&TTE). The R&TTE Directive repeals and replaces in the directive 98/13/EEC (Telecommunications Terminal Equipment and Satellite Earth Station Equipment) As of April 8, 2000.

Safety

This equipment is designed with the utmost care for the safety of those who install and use it. However, special attention must be paid to the dangers of electric shock and static electricity when working with electrical equipment. All guidelines of this and of the computer manufacture must therefore be allowed at all times to ensure the safe use of the equipment.

EU Countries Intended for Use

The ETSI version of this device is intended for home and office use in Austria, Belgium, Bulgaria, Cyprus, Czech, Denmark, Estonia, Finland, France, Germany, Greece, Hungary, Ireland, Italy, Latvia, Lithuania, Luxembourg, Malta, Netherlands, Poland, Portugal, Romania, Slovakia, Slovenia, Spain, Sweden, Turkey, and United Kingdom. The ETSI version of this device is also authorized for use in EFTA member states: Iceland, Liechtenstein, Norway, and Switzerland.

EU Countries Not Intended for Use

None

EU Declaration of Conformity

- English:** This equipment is in compliance with the essential requirements and other relevant provisions of Directive 1999/5/EC, 2009/125/EC.
- Français:** Cet équipement est conforme aux exigences essentielles et autres dispositions de la directive 1999/5/CE, 2009/125/CE.
- Čeština:** Toto zařízení je v souladu se základními požadavky a ostatními příslušnými ustanoveními směrnic 1999/5/ES, 2009/125/ES.
- Polski:** Urządzenie jest zgodne z ogólnymi wymaganiami oraz szczególnymi warunkami określonymi Dyrektywą UE 1999/5/EC, 2009/125/EC.
- Română:** Acest echipament este în conformitate cu cerințele esențiale și alte prevederi relevante ale Directivei 1999/5/CE, 2009/125/CE.
- Русский:** Это оборудование соответствует основным требованиям и положениям Директивы 1999/5/EC, 2009/125/EC.
- Magyar:** Ez a berendezés megfelel az alapvető követelményeknek és más vonatkozó irányelveknek (1999/5/EK, 2009/125/EC).
- Türkçe:** Bu cihaz 1999/5/EC, 2009/125/EC direktifleri zorunlu istekler ve diğer hükümlerle ile uyumludur.
- Українська:** Обладнання відповідає вимогам і умовам директиви 1999/5/EC, 2009/125/EC.
- Slovenčina:** Toto zariadenie spĺňa základné požiadavky a ďalšie príslušné ustanovenia smerníc 1999/5/ES, 2009/125/ES.
- Deutsch:** Dieses Gerät erfüllt die Voraussetzungen gemäß den Richtlinien 1999/5/EC, 2009/125/EC.
- Español:** El presente equipo cumple los requisitos esenciales de la Directiva 1999/5/EC, 2009/125/EC.
- Italiano:** Questo apparecchio è conforme ai requisiti essenziali e alle altre disposizioni applicabili della Direttiva 1999/5/CE, 2009/125/CE.
- Nederlands:** Dit apparaat voldoet aan de essentiële eisen en andere van toepassing zijnde bepalingen van richtlijn 1999/5/EC, 2009/125/EC.
- Português:** Este equipamento cumpre os requisitos essenciais da Directiva 1999/5/EC, 2009/125/EC.
- Norsk:** Dette utstyret er i samsvar med de viktigste kravene og andre relevante regler i Direktiv 1999/5/EC, 2009/125/EC.
- Svenska:** Denna utrustning är i överensstämmelse med de väsentliga kraven och övriga relevanta bestämmelser i direktiv 1999/5/EG, 2009/125/EG.
- Dansk:** Dette udstyr er i overensstemmelse med de væsentligste krav og andre relevante forordninger i direktiv 1999/5/EC, 2009/125/EC.
- Suomi:** Tämä laite täyttää direktiivien 1999/5/EY, 2009/125/EY oleelliset vaatimukset ja muut asiaankuuluvat määräykset.

FOR USE IN



WEEE Directive & Product Disposal



At the end of its serviceable life, this product should not be treated as household or general waste. It should be handed over to the applicable collection point for the recycling of electrical and electronic equipment, or returned to the supplier for disposal.

Declaration of Conformity

We, Edimax Technology Co., Ltd., declare under our sole responsibility, that the equipment described below complies with the requirements of the European R&TTE directives 1999/5/EC, directive 2011/65/EC (RoHS) and directive 2009/125/EC (ErP).

Equipment: AC1200 Gigabit Dual-Band Router with VPN

Model No.: BR-6478AC V2

The following European standards for essential requirements have been followed:

Directives 1999/5/EC

Spectrum : ETSI EN 300 328 V1.8.1 (2012);
ETSI EN 301 893 V1.7.1 (2012)
EMC : EN 301 489-1 V1.9.2 (2011-09);
EN 301 489-17 V2.2.1 (2012-09);
Safety (LVD) : IEC 60950-1:2005 (2nd Edition)+A1:2009+A2:2013
EN 60950-1:2006+A11:2009+A1:2010+A12:2011+A2:2013

Recommendation 99/519/EC

EMF : EN 62311: 2008

Directives 2006/95/EC

Safety (LVD) : IEC 60950-1:2005 (2nd Edition)+A1:2009+A2:2013
EN 60950-1:2006+A11:2009+A1:2010+A12:2011+A2:2013

Edimax Technology Co., Ltd.
No. 3, Wu Chuan 3rd Road,
Wu-Ku Industrial Park,
New Taipei City, Taiwan



Date of Signature: Sep, 2015

Signature:

Printed Name:

Albert Chang

Title:

Director

Edimax Technology Co., Ltd.



ΣDIMAX
NETWORKING PEOPLE TOGETHER